

# CAMELEON

SYSTEM

Light for your home  
Since 1994

Nowodvorski  
L I G H T I N G

# CAMELEON SYSTEM

UNLIMITED POSSIBILITIES  
NIEOGRANICZONE MOŻLIWOŚCI  
НЕОГРАНИЧЕННЫЕ ВОЗМОЖНОСТИ

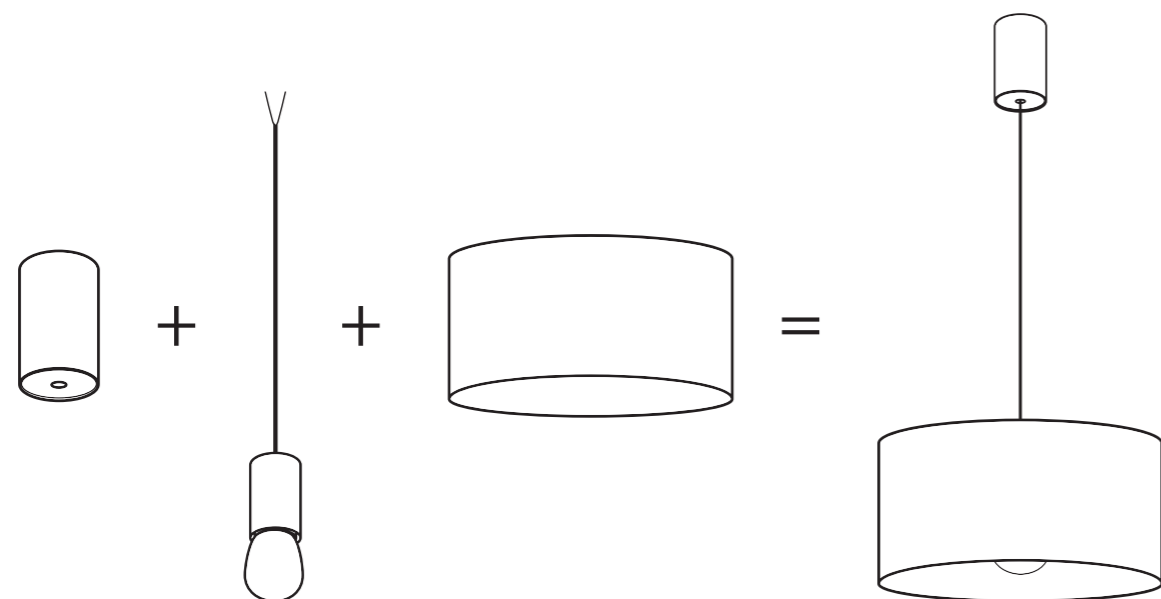

CREATE YOUR OWN LIGHT SYSTEM USING  
OUR ELEMENTS

STWÓRZ SWÓJ SYSTEM ŚWIETLNY WYBIERAJĄC NASZE ELEMENTY  
СОЗДАЙ СВОЙ СВЕТ, ВЫБИРАЯ НАШИ КОМПОНЕНТЫ

# HOW IT WORKS?

JAK TO DZIAŁA?  
КАК ЭТО РАБОТАЕТ?

CHOOSE

WYBIERZ  
ВЫБРАТЬ

BUY

KUP  
КУПИТЬ

ASSEMBLE

ZŁÓŻ  
СОБИРАТЬ

SCAN QR CODE TO LEARN HOW IT WORKS

ZESKANUJ KOD QR ABY DOWIEDZIEĆ SIĘ WIĘCEJ  
СКАНИРУЙТЕ QR-КОД, ЧТОБЫ УЗНАТЬ, КАК ОНО РАБОТАЕТ



COMPLETE LAMP

KOMPLETNA LAMPA  
ЗАВЕРШЕННЫЙ СВЕТИЛЬНИК

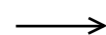
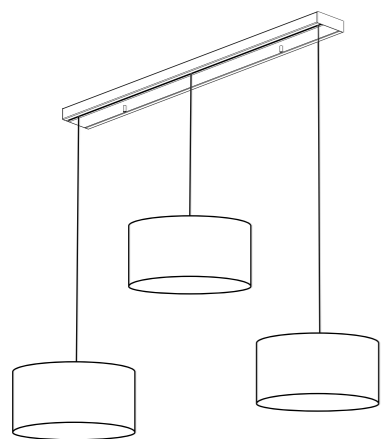

CAMELEON LAMP SHADES

CAMELEON KLOSZE  
CAMELEON ПЛАФОНЫ

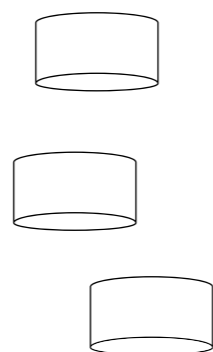

CAMELEON SUSPENSION

CAMELEON ZAWIESZENIE  
CAMELEON ПОДВЕС

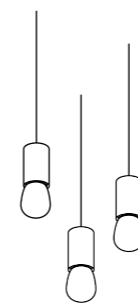

CAMELEON FIXING

CAMELEON AKCESORIA MONTAŻOWE  
CAMELEON АКЦЕССУАРЫ ДЛЯ КРЕПЛЕНИЯ

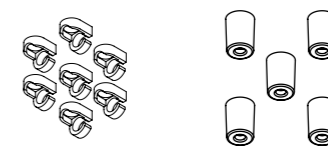
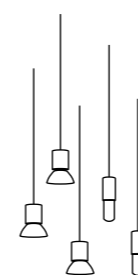
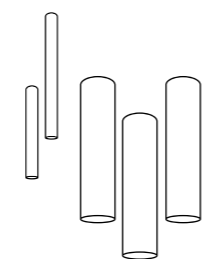
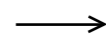
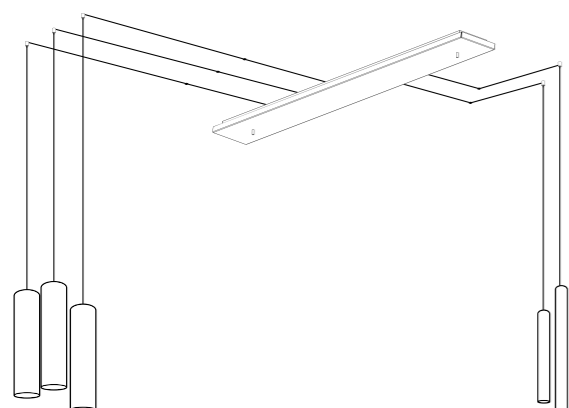
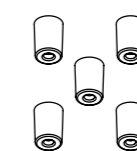
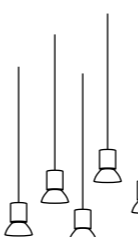
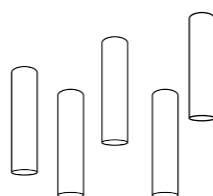
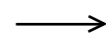
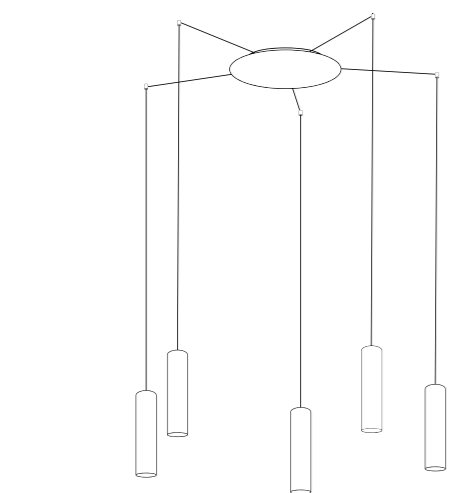
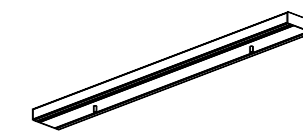

## CHOOSE

CHOOSE ELEMENTS TO CREATE PERFECTLY FUNCTIONAL LAMP FOR YOUR HOME

## WYBIERZ

WYBIERZ ELEMENTY DO ZŁOŻENIA LAMPY IDEALNIE DOPASOWANEJ DO TWOJEGO DOMU

## ВЫБРАТЬ

ВЫБЕРИТЕ ЭЛЕМЕНТЫ ДЛЯ СБОРКИ СВЕТИЛЬНИКА, ИДЕАЛЬНО ПОДОБРОННОГО К ВАШЕМУ ДОМУ

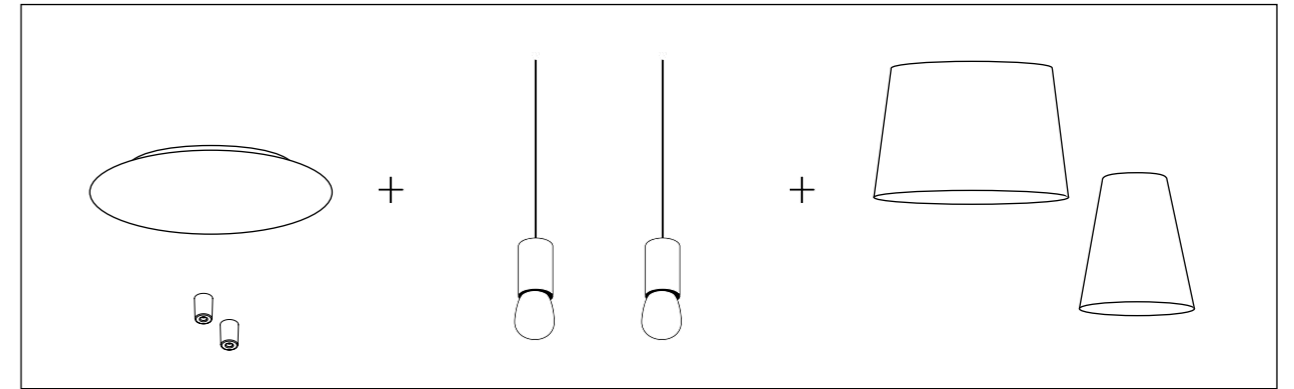

1. CHOOSE ELEMENTS TO CREATE PERFECTLY FUNCTIONAL LAMP FOR YOUR HOME

1. WYBIERZ ELEMENTY DO ZŁOŻENIA LAMPY IDEALNIE DOPASOWANEJ DO TWOJEGO DOMU

1. ВЫБЕРИТЕ ЭЛЕМЕНТЫ ДЛЯ СБОРКИ СВЕТИЛЬНИКА, ИДЕАЛЬНО ПОДОБРОННОГО К ВАШЕМУ ДОМУ

## BUY

BUY CORRECT AMOUNT OF :

- CAMELEON
- LAMP SHADES
- SUSPENSION
- CANOPY
- FIXING

## KUP

ODPOWIEDNIĄ ILOŚĆ ELEMENTÓW:

- CAMELEON
- KLOSZE
- ZAWIESZENIE
- PUSZKA
- AKCESORIA MONTAŻOWE

## КУПИТЬ

ПРАВИЛЬНОЕ КОЛИЧЕСТВО ЭЛЕМЕНТОВ:

- CAMELEON
- ПЛАФОНЫ
- ПОДВЕС
- ОСНОВАНИЕ
- АКССУАРЫ ДЛЯ КРЕПЛЕНИЯ

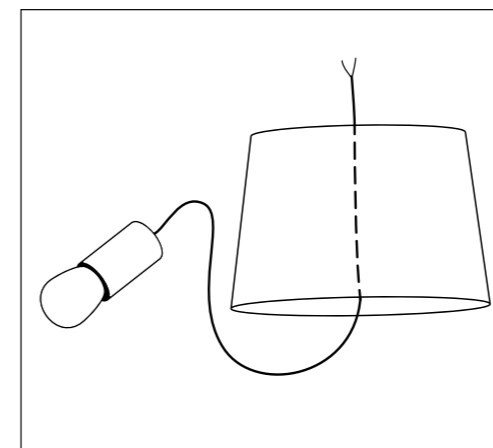

2. PUT THE SUSPENSION THROUGH THE LAMP SHADE

2. PRZEŁÓŻ ZAWIESZENIE PRZEZ KLOSZ

2. ПЕРЕМЕСТИ ПОДВЕС ЧЕРЕЗ ПЛАФОН

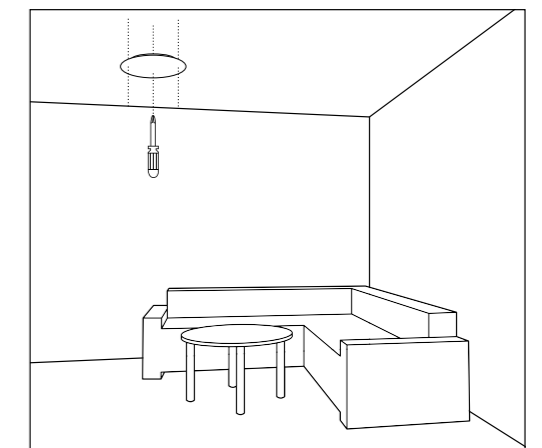

3. FIX THE CAMELEON CANOPY

3. PRZYKRĘĆ PUSZKĘ

3. ПРИВИНТИТЬ ОСНОВАНИЕ

## ASSEMBLE

EASY ASSEMBLING ACCORDING TO THE USER'S MANUAL

## ZŁÓŻ

ŁATWY MONTAŻ WEDŁUG ZAŁĄCZONEJ INSTRUKCJI

## СОБИРАТЬ

ЛЕГКАЯ СБОРКА В СООТВЕТСТВИИ С ПРИЛАГАЕМОЙ ИНСТРУКЦИЕЙ

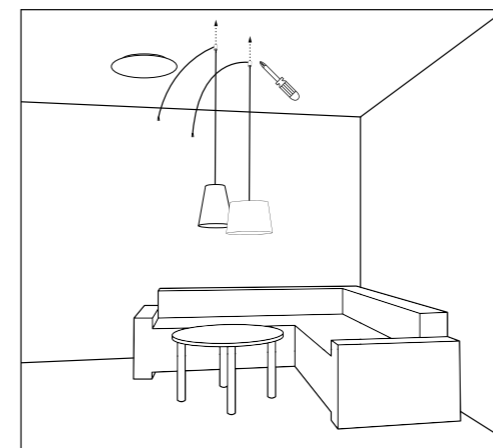

4. FIX THE SUSPENSION

4. ZAMOCUJ ZAWIESZENIE

4. КРЕПИТЬ ПОДВЕС

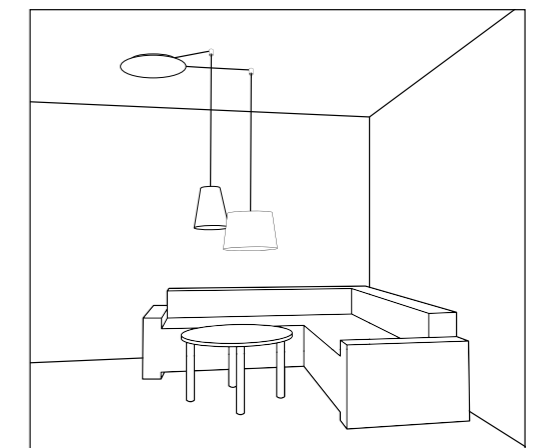

5. CONNECT THE FIXTURES TO THE CAMELEON CANOPY

5. PODŁĄCZ ZAWIESZENIE DO PUSZKI

5. ПОДКЛЮЧИТЬ СВЕТИЛЬНИК К ОСНОВАНИЮ CAMELEON





ELEMENTS INCLUDED / UŻYTE ELEMENTY / ИСПОЛЬЗОВАННЫЕ ЭЛЕМЕНТЫ

	ELEMENT	ITEM NO.	PAGE
1	CANOPY A	8563	69
2	CABLE GU10	8630	68
3	MOUNTING B	8393	73
4	MOUNTING A	8395	73
5	CYLINDER S	8546	38
6	CYLINDER M	8543	38
7	CYLINDER L	8540	38

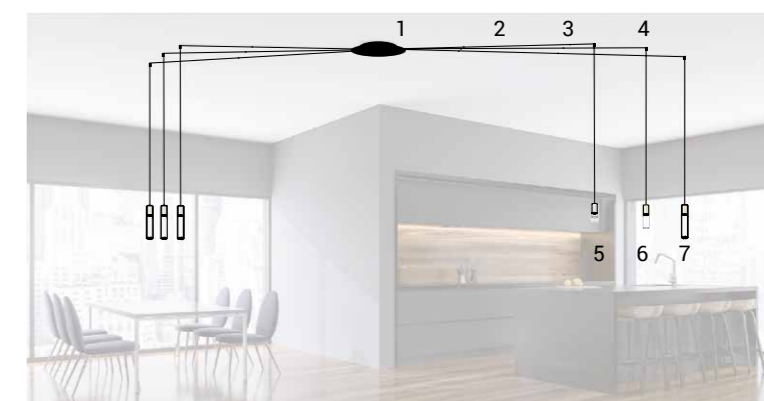



ELEMENTS INCLUDED / UŻYTE ELEMENTY / ИСПОЛЬЗОВАННЫЕ ЭЛЕМЕНТЫ

	ELEMENT	ITEM NO.	PAGE
1	CANOPY B 1500	8608	70
2	CABLE G9	8632	68
3	LASER 490	8572	28







ELEMENTS INCLUDED / UŻYTE ELEMENTY / ИСПОЛЬЗОВАННЫЕ ЭЛЕМЕНТЫ

ELEMENT	ITEM NO.	PAGE
1 CANOPY B 780	8561	70
2 CANOPY C 780	8556	71
3 CABLE G9	8632	68
4 CABLE E27	8670	68
5 LASER 750	8567	28
6 EGG M	8607	26



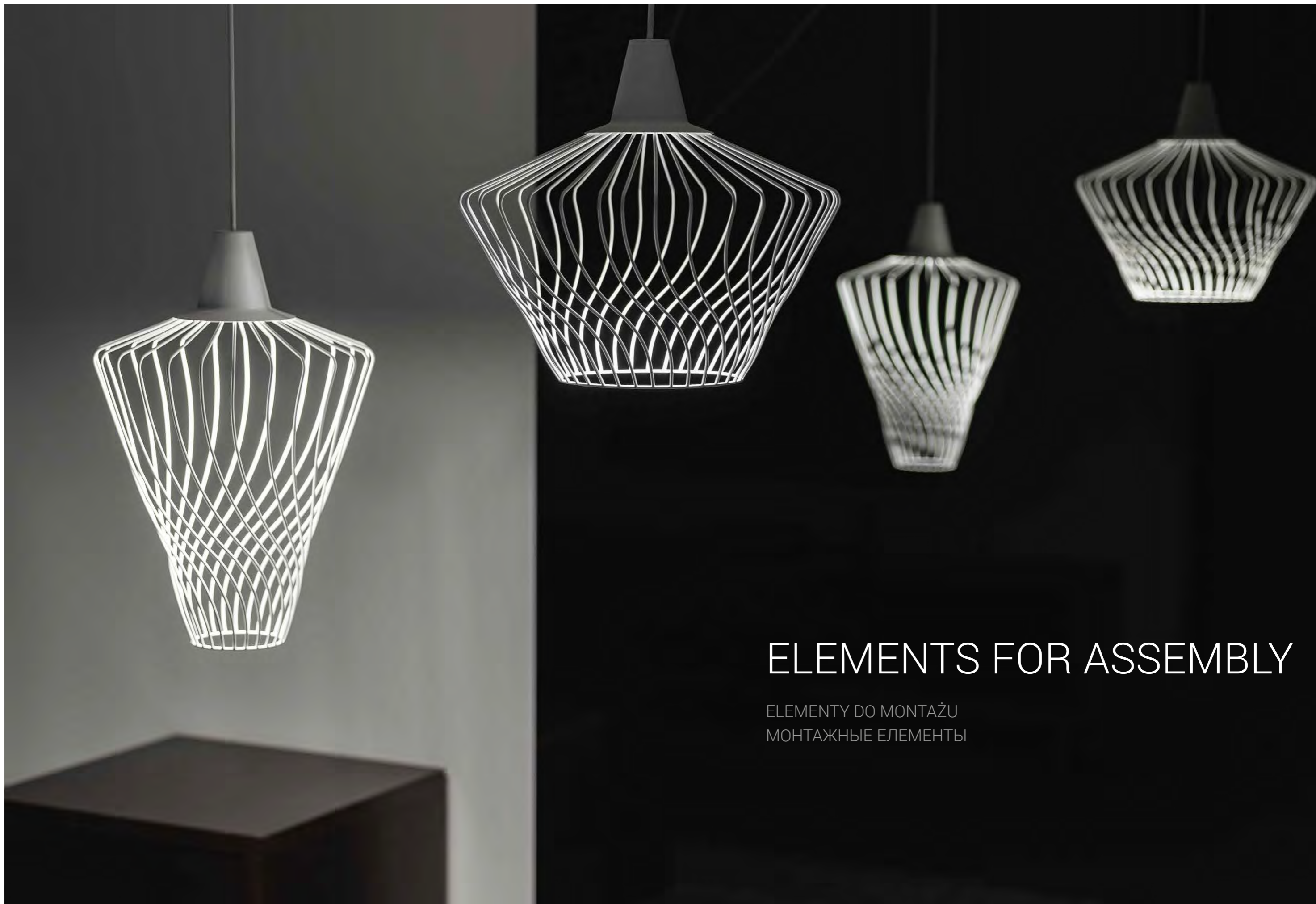

## ELEMENTS FOR ASSEMBLY

ELEMENTY DO MONTAŻU  
МОНТАЖНЫЕ ЭЛЕМЕНТЫ



**CAMELEON WAVE L**  
8600 G



## CAMELEON WAVE S

painted steel / stal lakierowana / лакированная сталь

8606 ○ WH 8605 ● BL

works with / zastosuj z / применять с

Ⓟ 1× CAMELEON CABLE E27

Ⓟ 1× CAMELEON CABLE GU10

electroplated brass / stal mosiądzowana / латунная сталь

8604 ● G

works with / zastosuj z / применять с

Ⓟ 1× CAMELEON CABLE E27

Ⓟ 1× CAMELEON CABLE GU10

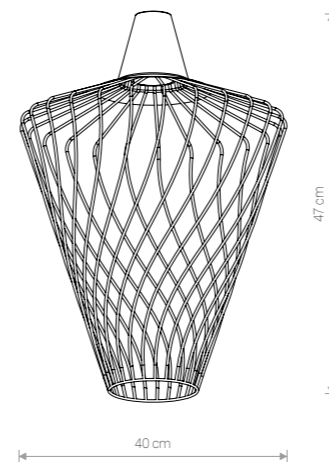

## CAMELEON WAVE L

painted steel / stal lakierowana / лакированная сталь

8603 ○ WH 8602 ● BL

works with / zastosuj z / применять с

Ⓟ 1× CAMELEON CABLE E27

Ⓟ 1× CAMELEON CABLE GU10

electroplated brass / stal mosiądzowana / латунная сталь

8600 ● G

works with / zastosuj z / применять с

Ⓟ 1× CAMELEON CABLE E27

Ⓟ 1× CAMELEON CABLE GU10

**CAMELEON WAVE S**  
8606 WH



**CAMELEON WAVE S**  
8604 G



**CAMELEON WAVE L**  
8602 BL





**CAMELEON LUKSOR L**  
8592 G

**CAMELEON LUKSOR S**  
8596 G

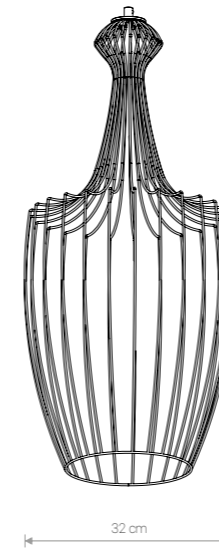

## CAMELEON LUKSOR L

painted steel / stal lakierowana / лакированная сталь

8593 ● BL

works with / zastosuj z / применять с

Ⓛ 1× CAMELEON CABLE E27

electroplated brass / stal mosiadowana / латунная сталь

8592 ● G

works with / zastosuj z / применять с

Ⓛ 1× CAMELEON CABLE E27

**CAMELEON LUKSOR L**  
8593 BL

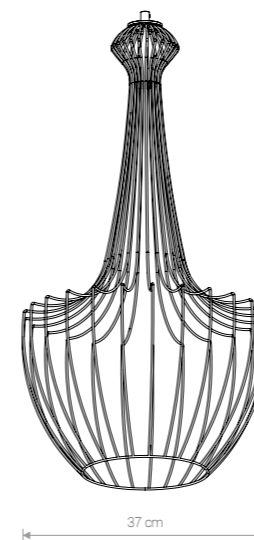

## CAMELEON LUKSOR S

painted steel / stal lakierowana / лакированная сталь

8597 ● BL

works with / zastosuj z / применять с

Ⓛ 1× CAMELEON CABLE E27

electroplated brass / stal mosiadowana / латунная сталь

8596 ● G

works with / zastosuj z / применять с

Ⓛ 1× CAMELEON CABLE E27

**CAMELEON LUKSOR S**  
8597 BL



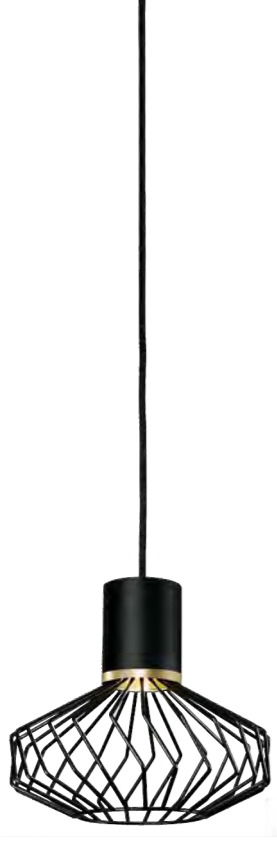

**CAMELEON PICO A**  
8591 BL/G



**CAMELEON PICO B**  
8590 BL/G



**CAMELEON PICO C**  
8588 BL/G



**CAMELEON ABI M**  
8582 BL



**CAMELEON ABI S**  
8586 BL



**CAMELEON ABI L**  
8577 BL

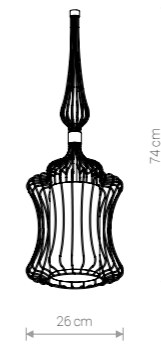
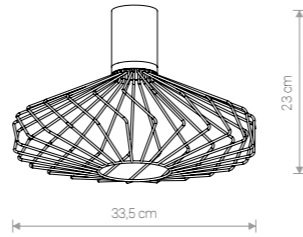
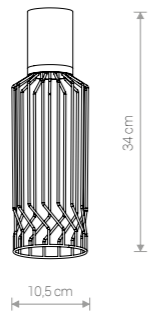
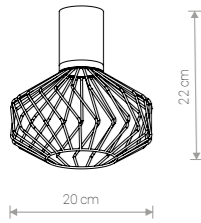

## CAMELEON PICO A

painted steel, electroplated brass /  
stal lakierowana, stal mosiądzowana /  
лакированная сталь, латунная сталь

8591 ● BL/G

works with / zastosuj z / применять с

Ⓢ 1× CAMELEON CABLE GU10

## CAMELEON PICO B

painted steel, electroplated brass /  
stal lakierowana, stal mosiądzowana /  
лакированная сталь, латунная сталь

8590 ● BL/G

works with / zastosuj z / применять с

Ⓢ 1× CAMELEON CABLE GU10

## CAMELEON PICO C

painted steel, electroplated brass /  
stal lakierowana, stal mosiądzowana /  
лакированная сталь, латунная сталь

8588 ● BL/G

works with / zastosuj z / применять с

Ⓢ 1× CAMELEON CABLE GU10

## CAMELEON ABI M

painted steel, shade / stal lakierowana, abażur /  
лакированная сталь, абажур

8584 ○ WH 8582 ● BL

works with / zastosuj z / применять с

Ⓢ 1× CAMELEON CABLE E27

## CAMELEON ABI S

painted steel, shade / stal lakierowana, abażur /  
лакированная сталь, абажур

8587 ○ WH 8586 ● BL

works with / zastosuj z / применять с

Ⓢ 1× CAMELEON CABLE E27

## CAMELEON ABI L

painted steel, shade / stal lakierowana, abażur /  
лакированная сталь, абажур

8581 ○ WH 8577 ● BL

works with / zastosuj z / применять с

Ⓢ 1× CAMELEON CABLE E27

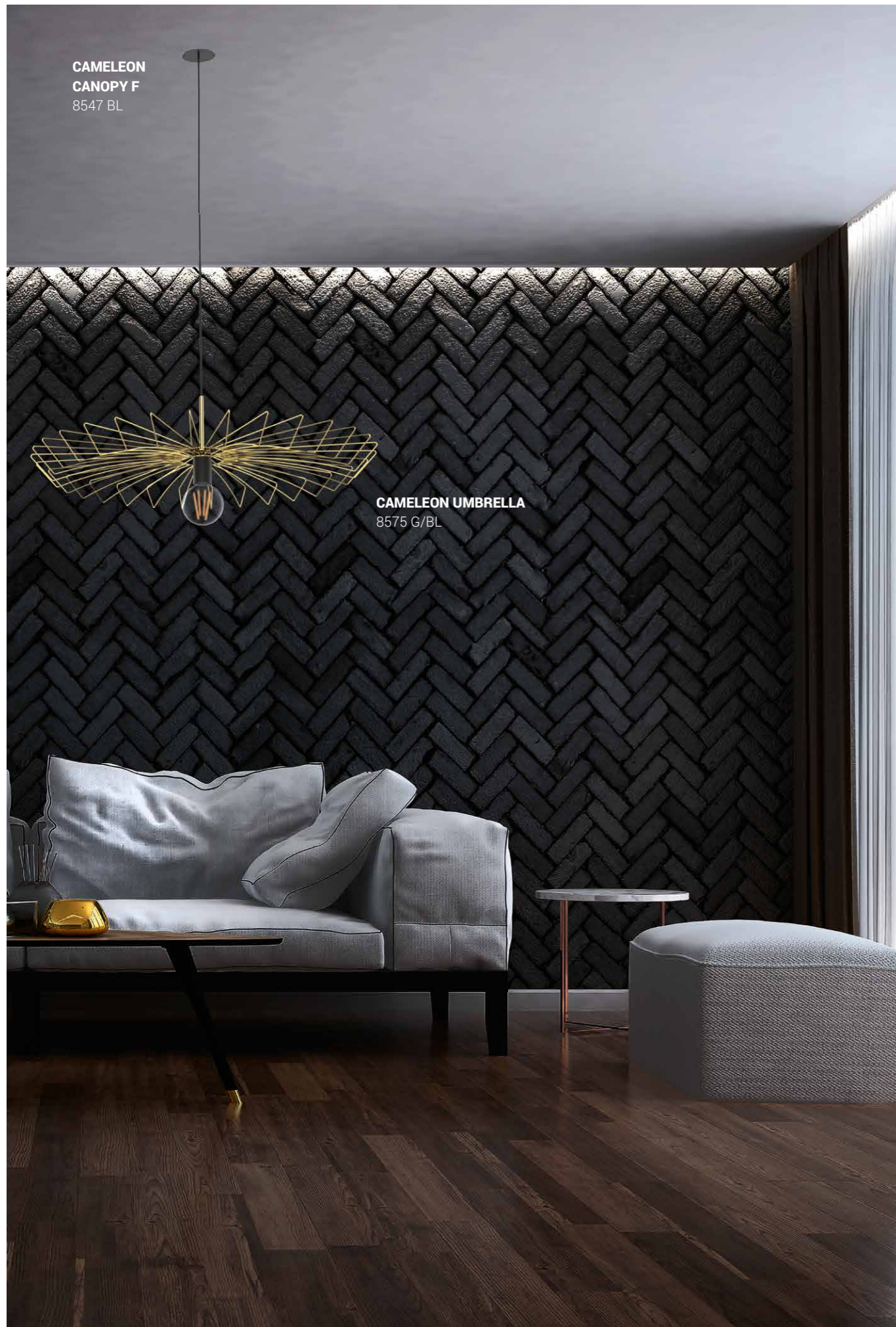

CAMELEON  
CANOPY F  
8547 BL

CAMELEON UMBRELLA  
8575 G/BL



CAMELEON UMBRELLA  
8574 BL

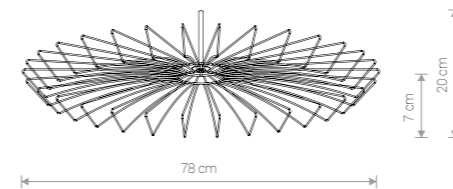

## CAMELEON UMBRELLA

electroplated brass, painted steel /  
stal miedzowana, stal lakierowana /  
латунная сталь, лакированная сталь

8575 ● G/BL

works with / zastosuj z / применять с

📍 1× CAMELEON CABLE E27



CAMELEON GSTAR  
8576 G/BL

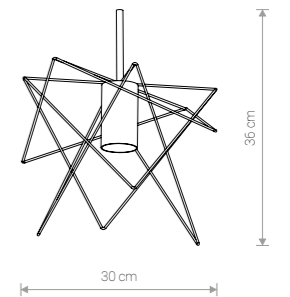

## CAMELEON GSTAR

electroplated brass, painted steel /  
stal miedzowana, stal lakierowana /  
латунная сталь, лакированная сталь

8576 ● G/BL

works with / zastosuj z / применять с

📍 1× CAMELEON CABLE GU10



**CAMELEON EGG M**  
8607 BL/G

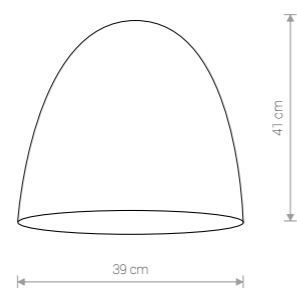

## CAMELEON EGG M

composite / kompozyt / композитный

8607 ● BL/G

works with / zastosuj z / применять с

Ⓟ 1x CAMELEON CABLE E27



**CAMELEON  
CANOPY B 780**  
8561 BL

**CAMELEON EGG M**  
8607 BL/G



## CAMELEON LASER 490

painted steel / stal lakierowana / лакированная сталь

8573 ○ WH 8572 ● BL

works with / zastosuj z / применять с

Ⓛ 1× CAMELEON CABLE G9

brass / miedz / латунь

8571 ● BS

works with / zastosuj z / применять с

Ⓛ 1× CAMELEON CABLE G9

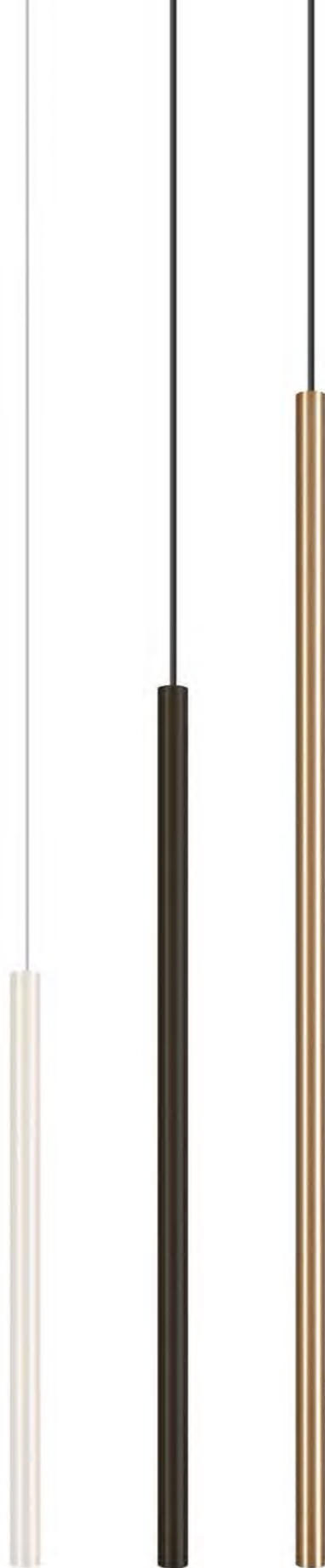

**CAMELEON LASER 490**  
8573 WH

**CAMELEON LASER 750**  
8568 BL

**CAMELEON LASER 1000**  
8486 BS



## CAMELEON LASER 750

painted steel / stal lakierowana / лакированная сталь

8570 ○ WH 8568 ● BL

works with / zastosuj z / применять с

Ⓛ 1× CAMELEON CABLE G9

brass / miedz / латунь

8567 ● BS

works with / zastosuj z / применять с

Ⓛ 1× CAMELEON CABLE G9



## CAMELEON LASER 1000

painted steel / stal lakierowana / лакированная сталь

8488 ○ WH 8487 ● BL

works with / zastosuj z / применять с

Ⓛ 1× CAMELEON CABLE G9

brass / miedz / латунь

8486 ● BS

works with / zastosuj z / применять с

Ⓛ 1× CAMELEON CABLE G9



**CAMELEON CANOPY C 780**  
8556 BL

**CAMELEON LASER 750**  
8567 BS





**CAMELEON EYE M**  
8485 BS

**CAMELEON EYE L**  
8484 BS

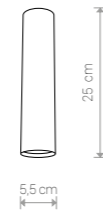

### CAMELEON EYE M

brass / miedź / латунь

8485 ● BS

works with / zastosuj z / применять с

Ⓛ 1× CAMELEON CABLE GU10



### CAMELEON EYE M

painted steel / stal lakierowana /  
лакированная сталь

8483 ○ WH 8478 ○ SI

8476 ● GR 8481 ● BL

works with / zastosuj z / применять с

Ⓛ 1× CAMELEON CABLE GU10



**CAMELEON EYE M**  
8478 SI



**CAMELEON EYE L**  
8475 GR



**CAMELEON EYE L**  
8482 WH

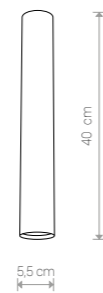

### CAMELEON EYE L

brass / miedź / латунь

8484 ● BS

works with / zastosuj z / применять с

Ⓛ 1× CAMELEON CABLE GU10



### CAMELEON EYE L

painted steel / stal lakierowana /  
лакированная сталь

8482 ○ WH 8477 ○ SI

8475 ● GR 8480 ● BL

works with / zastosuj z / применять с

Ⓛ 1× CAMELEON CABLE GU10



**CAMELEON POLY L**  
8472 WH



**CAMELEON POLY M**  
8473 BL

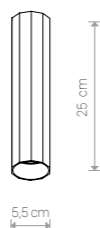

### CAMELEON POLY M

painted aluminum / aluminium lakierowane /  
лакированный алюминий

8474 ○ WH 8473 ● BL

works with / zastosuj z / применять с

📍 1x CAMELEON CABLE GU10



### CAMELEON POLY L

painted aluminum / aluminium lakierowane /  
лакированный алюминий

8472 ○ WH 8471 ● BL

works with / zastosuj z / применять с

📍 1x CAMELEON CABLE GU10



**CAMELEON TULUM**  
8467 CN



**CAMELEON TULUM**  
8426 CN

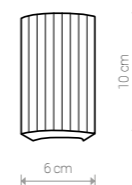

### CAMELEON TULUM

concrete / beton / бетон

8467 ● CN

works with / zastosuj z / применять с

📍 1x CAMELEON CABLE E27



### CAMELEON TULUM

concrete / beton / бетон

8426 ● CN

works with / zastosuj z / применять с

📍 1x CAMELEON CABLE E27



**CAMELEON GEOMETRIC C**  
8465 CN

**CAMELEON GEOMETRIC A**  
8466 CN



**CAMELEON GEOMETRIC A**  
8466 CN



**CAMELEON GEOMETRIC B**  
8425 CN



**CAMELEON GEOMETRIC C**  
8465 CN

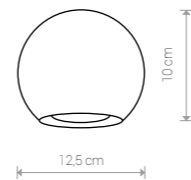

**CAMELEON  
GEOMETRIC A**

concrete / beton / бетон

8466 ● CN

works with / zastosuj z / применять с

💡 1x CAMELEON CABLE GU10

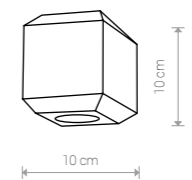

**CAMELEON  
GEOMETRIC B**

concrete / beton / бетон

8425 ● CN

works with / zastosuj z / применять с

💡 1x CAMELEON CABLE GU10

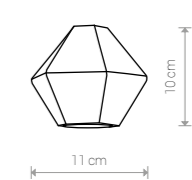

**CAMELEON  
GEOMETRIC C**

concrete / beton / бетон

8465 ● CN

works with / zastosuj z / применять с

💡 1x CAMELEON CABLE GU10

**CAMELEON  
CANOPY G**  
8360 BL

**CAMELEON CYLINDER M**  
8543 TR/BS

This arrangement was made of elements from **PROFILE TRACK** system that is presented in Nowodvorski Lighting 2019/20 catalogue.

Na aranżacji wykorzystano element systemu **PROFILE TRACK** znajdujący się w ofercie prezentowanej w Katalogu 2019/2020.

В данной визуализации использованы элементы системы **PROFILE TRACK**, которая представлена в каталоге 2019/20.



**CAMELEON CYLINDER L**  
8540 TR/BS

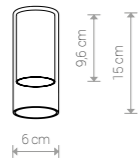

**CAMELEON CYLINDER S**

glass, painted steel / szkło, stal laskierowana /  
стекло, лакированная сталь

8544 ● TR/BL 8545 ○ TR/WH

works with / zastosuj z / применять с

1x CAMELEON CABLE GU10

glass, brass / szkło, miedz /  
стекло, латунь

8546 ● TR/BS

works with / zastosuj z / применять с

1x CAMELEON CABLE GU10



**CAMELEON CYLINDER S**  
8544 TR/BL

**CAMELEON CYLINDER M**  
8542 TR/WH

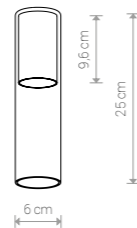

**CAMELEON CYLINDER M**

glass, painted steel / szkło, stal laskierowana /  
стекло, лакированная сталь

8541 ● TR/BL 8542 ○ TR/WH

works with / zastosuj z / применять с

1x CAMELEON CABLE GU10

glass, brass / szkło, miedz /  
стекло, латунь

8543 ● TR/BS

works with / zastosuj z / применять с

1x CAMELEON CABLE GU10

1 x GU10 not included

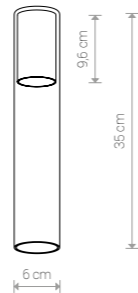

**CAMELEON CYLINDER L**

glass, painted steel / szkło, stal laskierowana /  
стекло, лакированная сталь

8537 ● TR/BL 8538 ○ TR/WH

works with / zastosuj z / применять с

1x CAMELEON CABLE GU10

glass, brass / szkło, miedz /  
стекло, латунь

8540 ● TR/BS

works with / zastosuj z / применять с

1x CAMELEON CABLE GU10

1 x G9 not included

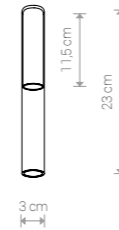

**CAMELEON STRAW S**

glass, painted steel / szkło, stal laskierowana /  
стекло, лакированная сталь

8400 ● TR/BL 8536 ○ TR/WH

works with / zastosuj z / применять с

1x CAMELEON CABLE G9

glass, brass / szkło, miedz /  
стекло, латунь

8401 ● TR/BS

works with / zastosuj z / применять с

1x CAMELEON CABLE G9

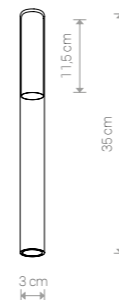

**CAMELEON STRAW M**

glass, painted steel / szkło, stal laskierowana /  
стекло, лакированная сталь

8402 ● TR/BL 8535 ○ TR/WH

works with / zastosuj z / применять с

1x CAMELEON CABLE G9

glass, brass / szkło, miedz /  
стекло, латунь

8403 ● TR/BS

works with / zastosuj z / применять с

1x CAMELEON CABLE G9



**CAMELEON STRAW S**  
8536 TR/WH

**CAMELEON STRAW M**  
8402 TR/BL





**CAMELEON PEAR L**  
8532 TR/G

**CAMELEON PEAR M**  
8533 TR/G

**CAMELEON PEAR S**  
8534 TR/G

**CAMELEON  
CANOPY A**  
8563 BL

**CAMELEON  
CABLE WITH  
SWITCH**  
8611 BL



**CAMELEON PEAR S**  
8534 TR/G

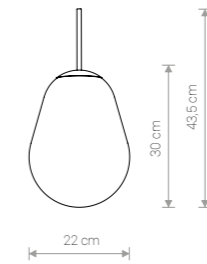

## CAMELEON PEAR S

glass, electroplated brass / szkło, stal mosiądzowana /  
стекло, латунная сталь

8534 TR/G

works with / zastosuj z / применять с

1 × CAMELEON CABLE E27

1 × CAMELEON CABLE G9



**CAMELEON PEAR M**  
8533 TR/G

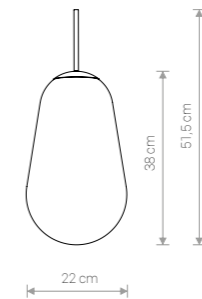

## CAMELEON PEAR M

glass, electroplated brass / szkło, stal mosiądzowana /  
стекло, латунная сталь

8533 TR/G

works with / zastosuj z / применять с

1 × CAMELEON CABLE E27

1 × CAMELEON CABLE G9



**CAMELEON PEAR L**  
8532 TR/G

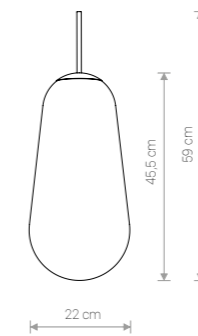

## CAMELEON PEAR L

glass, electroplated brass / szkło, stal mosiądzowana /  
стекло, латунная сталь

8532 TR/G

works with / zastosuj z / применять с

1 × CAMELEON CABLE E27

1 × CAMELEON CABLE G9



**CAMELEON SPHERE S**  
8531 TR



**CAMELEON SPHERE M**  
8530 TR



**CAMELEON SPHERE L**  
8528 TR



**CAMELEON SPHERE XL**  
8527 TR

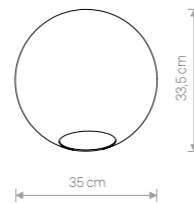
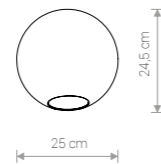
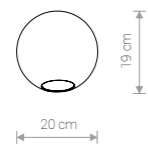
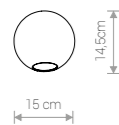

## CAMELEON SPHERE S

glass / szkło / стекло

8531 ○ TR

works with / zastosuj z / применять с

Ⓢ 1× CAMELEON CABLE G9

## CAMELEON SPHERE M

glass / szkło / стекло

8530 ○ TR

works with / zastosuj z / применять с

Ⓢ 1× CAMELEON CABLE E27

Ⓢ 1× CAMELEON CABLE G9

## CAMELEON SPHERE L

glass / szkło / стекло

8528 ○ TR

works with / zastosuj z / применять с

Ⓢ 1× CAMELEON CABLE E27

Ⓢ 1× CAMELEON CABLE G9

## CAMELEON SPHERE XL

glass / szkło / стекло

8527 ○ TR

works with / zastosuj z / применять с

Ⓢ 1× CAMELEON CABLE E27

Ⓢ 1× CAMELEON CABLE G9

**CAMELEON SPHERE XL**  
8527 TR

**CAMELEON SPHERE L**  
8528 TR

**CAMELEON SPHERE M**  
8530 TR

**CAMELEON SPHERE S**  
8531 TR







**CAMELEON BIO S**  
8458 NT



**CAMELEON BIO M**  
8461 WH

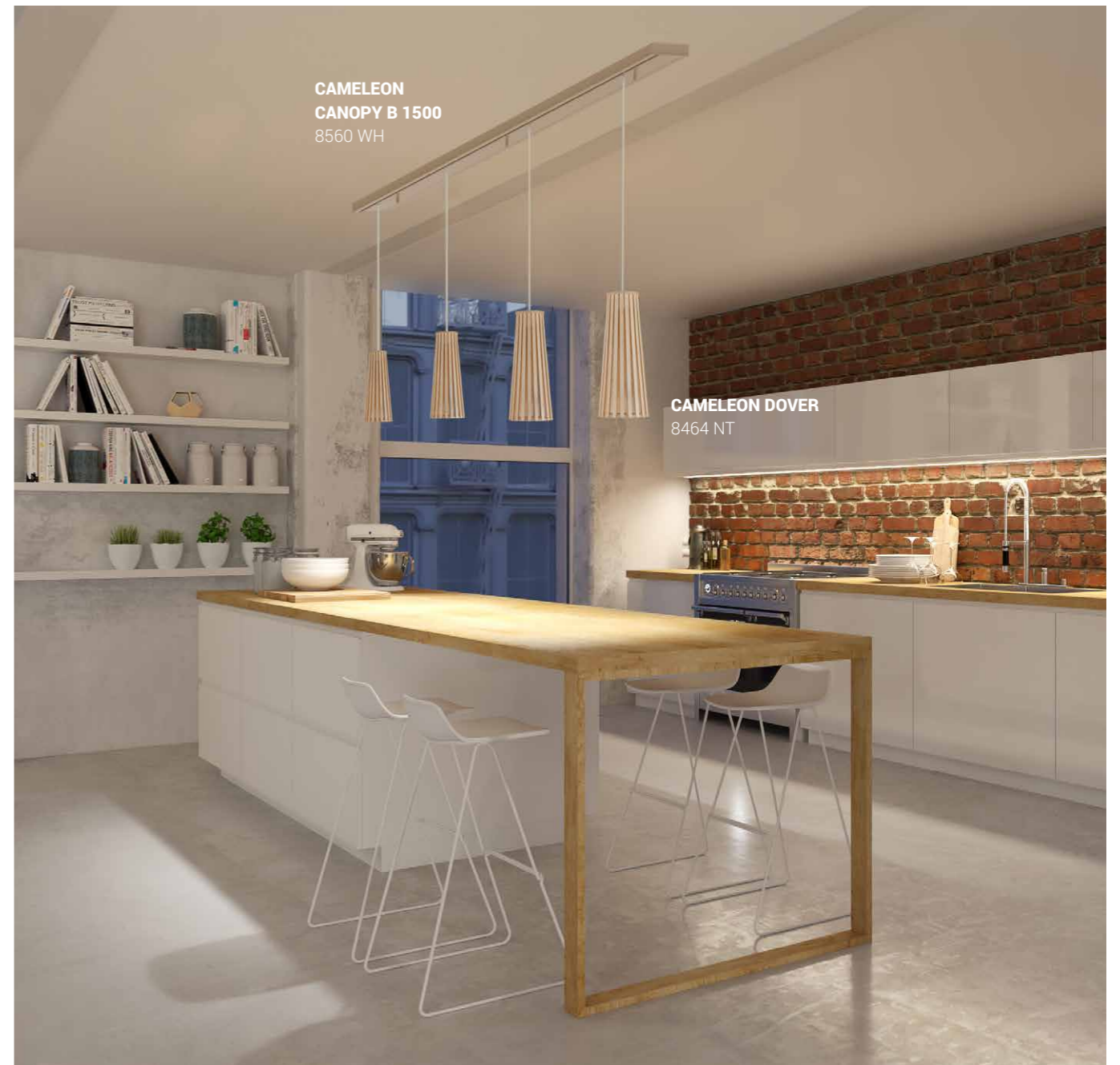

**CAMELEON CANOPY B 1500**  
8560 WH

**CAMELEON DOVER**  
8464 NT

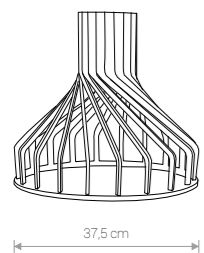

**CAMELEON BIO S**

plywood / sklejka / дерево

8458 ● NT 8457 ○ WH

works with / zastosuj z / применять с

Ⓛ 1× CAMELEON CABLE E27

Ⓛ 1× CAMELEON CABLE GU10

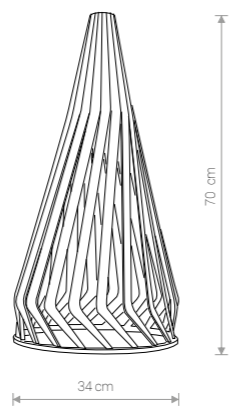

**CAMELEON BIO M**

plywood / sklejka / дерево

8462 ● NT 8461 ○ WH

works with / zastosuj z / применять с

Ⓛ 1× CAMELEON CABLE E27

Ⓛ 1× CAMELEON CABLE GU10

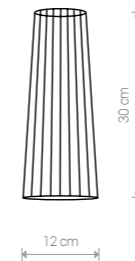

**CAMELEON DOVER**

plywood / sklejka / дерево

8464 ● NT 8463 ● BL

works with / zastosuj z / применять с

Ⓛ 1× CAMELEON CABLE GU10



**CAMELEON DOVER**  
8463 BL

**CAMELEON DOVER**  
8464 NT



**CAMELEON WHEEL**  
8424 G

**CAMELEON WHEEL**  
8423 BL

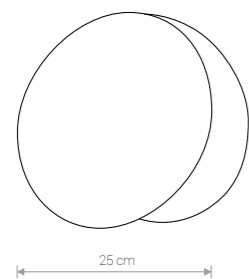

**CAMELEON  
WHEEL**

plywood, painted steel / sklejka, stal lakierowana /  
дерево, лакирована сталь

8424  G 8423  BL

works with / zastosuj z / применять с

 1x CAMELEON CABLE E27

**CAMELEON WHEEL**  
8423 BL



**CAMELEON WHEEL**  
8424 G



**CAMELEON CANOPY B 1500**  
8558 BL

**CAMELEON CONE M**  
8411 BL/G





**CAMELEON CONE M**  
8497 V NB/G



**CAMELEON CONE M**  
8411 BL/G



**CAMELEON CONE M**  
8414 V GN/G



**CAMELEON CONE L**  
8494 V PI/WH



**CAMELEON CONE L**  
8408 WH



**CAMELEON CONE L**  
8491 V BL

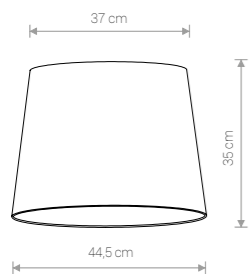

## CAMELEON CONE M

shade / abażur / абажур

8498 ○ V PI/WH 8497 ● V NB/G 8414 ● V GN/G 8496 ○ V WH 8495 ● V BL

8412 ● GY 8411 ● BL/G 8413 ○ WH

works with / zastosuj z / применять с

① 1× CAMELEON CABLE E27

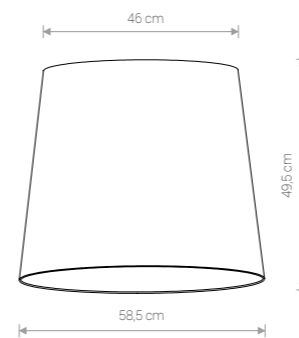

## CAMELEON CONE L

shade / abażur / абажур

8494 ○ V PI/WH 8493 ● V NB/G 8410 ● V GN/G 8492 ○ V WH 8491 ● V BL

8407 ● GY 8406 ● BL/G 8408 ○ WH

works with / zastosuj z / применять с

① 1× CAMELEON CABLE E27



**CAMELEON CONE S**  
8502 V PI/WH

**CAMELEON CONE S**  
8503 V GN/G

**CAMELEON CONE S**  
8501 V NB/G

**CAMELEON CONE S**  
8504 BL/G

**CAMELEON CONE S**  
8415 V BL

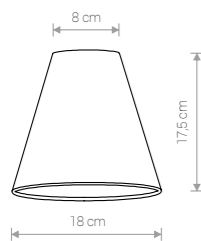

## CAMELEON CONE S

shade / abažur / абажур

8502 V PI/WH 8501 V NB/G 8503 V GN/G 8500 V WH 8415 V BL

8505 GY 8504 BL/G 8416 WH

works with / zastosuj z / применять с

1x CAMELEON CABLE E27

1x CAMELEON CABLE GU10

1x CAMELEON CABLE G9

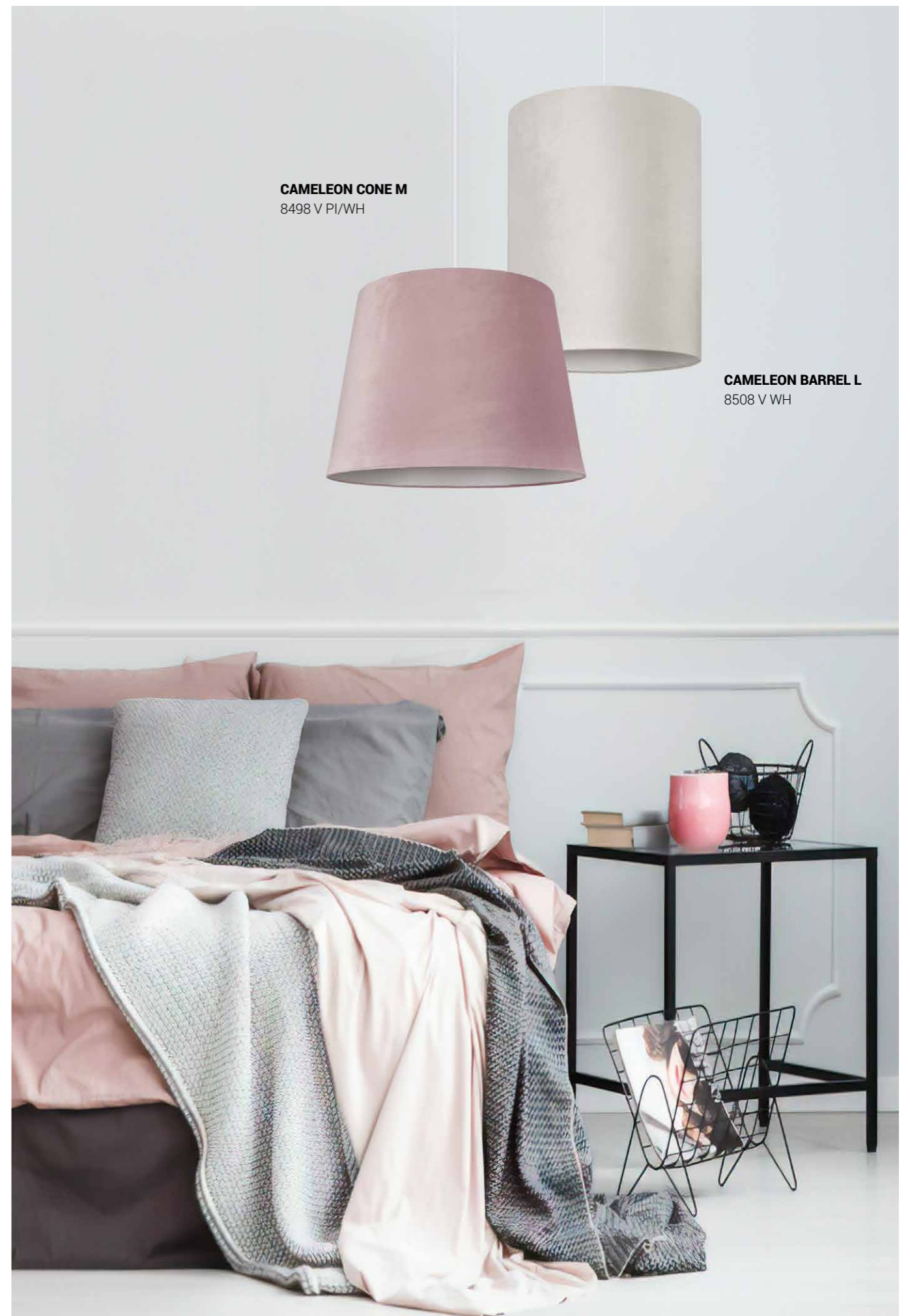

**CAMELEON CONE M**  
8498 V PI/WH

**CAMELEON BARREL L**  
8508 V WH

**CAMELEON  
CANOPY A**  
8563 BL

**CAMELEON  
BARREL WIDE S**  
8512 V GN/G

**CAMELEON  
BARREL L**  
8417 V GN/G





**CAMELEON  
BARREL WIDE S**  
8518 WH



**CAMELEON  
BARREL WIDE S**  
8517 GY



**CAMELEON  
BARREL WIDE S**  
8515 V PI/WH



**CAMELEON  
BARREL WIDE S**  
8514 V NB/G



**CAMELEON  
BARREL THIN S**  
8520 V GN/G



**CAMELEON  
BARREL THIN S**  
8422 V BL



**CAMELEON  
BARREL THIN S**  
8522 V NB/G



**CAMELEON  
BARREL THIN S**  
8521 V WH

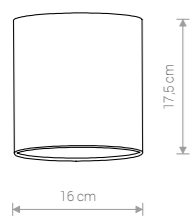

## CAMELEON BARREL WIDE S

shade / abażur / абажур

8515 V PI/WH 8514 V NB/G 8512 V GN/G 8513 V WH 8421 V BL

8517 GY 8516 BL/G 8518 WH

works with / zastosuj z / применять с

- 1× CAMELEON CABLE E27
- 1× CAMELEON CABLE GU10
- 1× CAMELEON CABLE G9

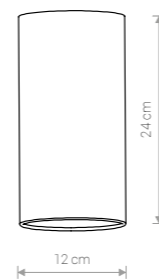

## CAMELEON BARREL THIN S

shade / abażur / абажур

8523 V PI/WH 8522 V NB/G 8520 V GN/G 8521 V WH 8422 V BL

8525 GY 8524 BL/G 8526 WH

works with / zastosuj z / применять с

- 1× CAMELEON CABLE E27
- 1× CAMELEON CABLE GU10
- 1× CAMELEON CABLE G9

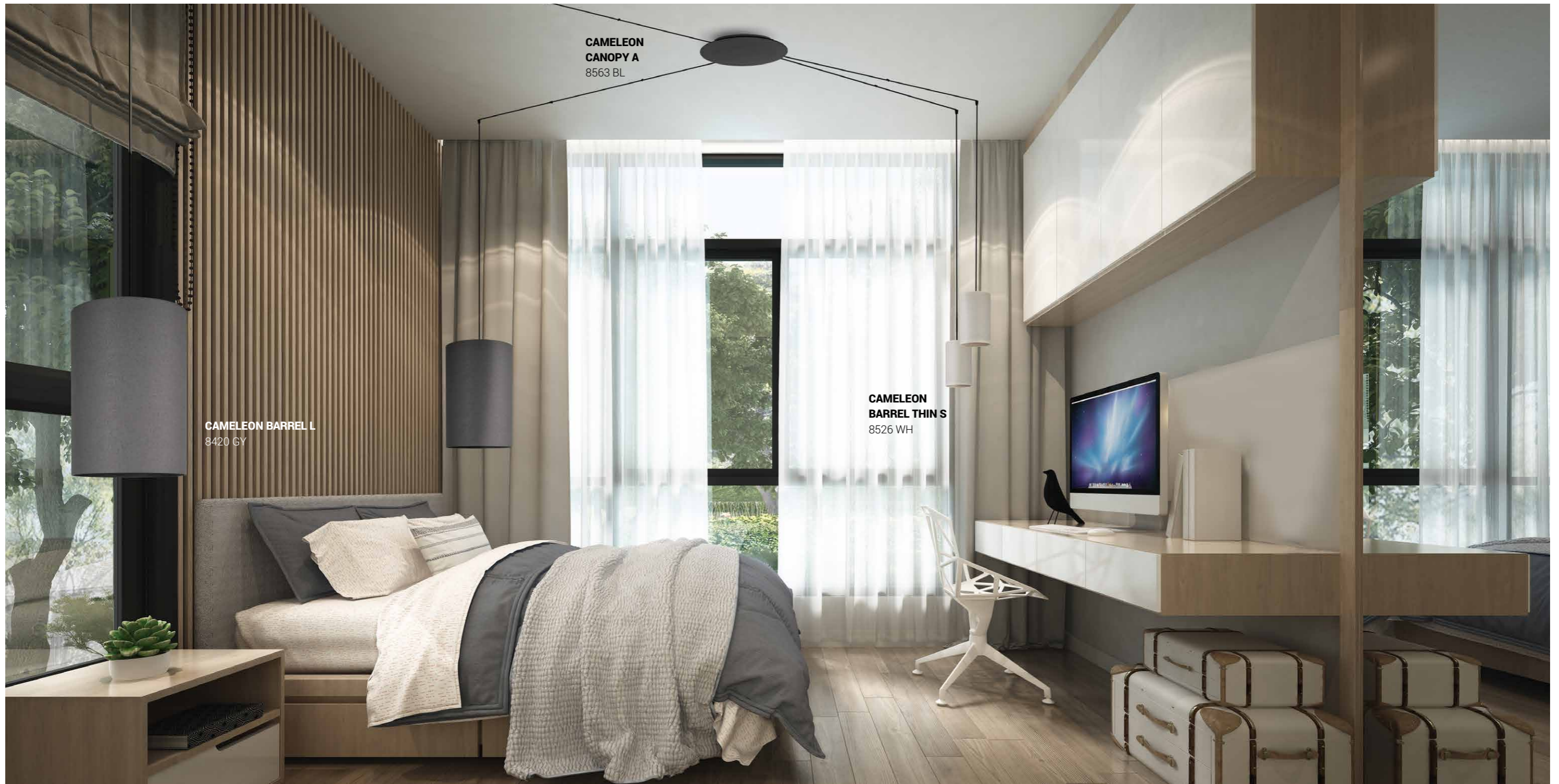

**CAMELEON  
CANOPY A**  
8563 BL

**CAMELEON BARREL L**  
8420 GY

**CAMELEON  
BARREL THIN S**  
8526 WH

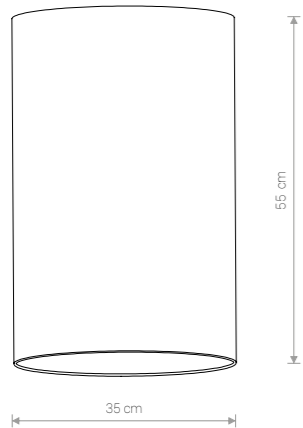

**CAMELEON  
BARREL L**

shade / abażur / абажур

8511 V PI/WH    8510 V NB/G    8417 V GN/G    8508 V WH    8507 V BL

8420 GY    8418 BL/G    8506 WH

works with / zastosuj z / применять с

1x CAMELEON CABLE E27



**CAMELEON BARREL L**  
8420 GY

**CAMELEON BARREL L**  
8506 WH



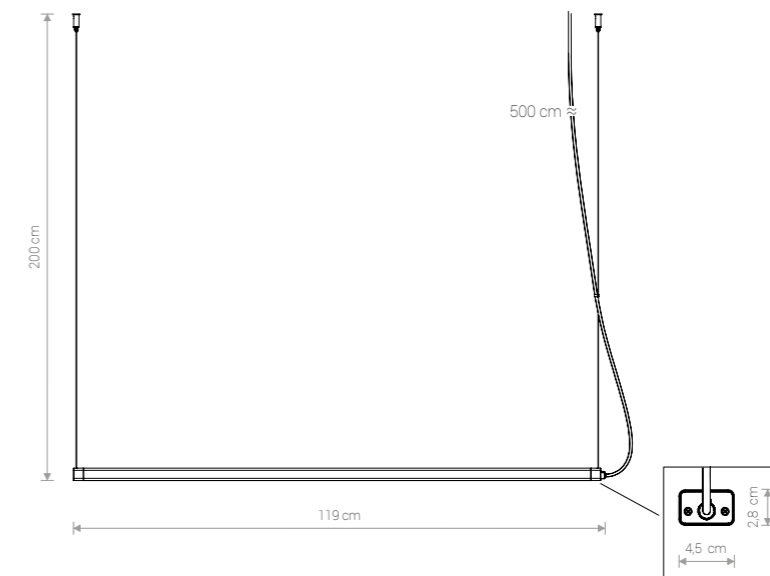
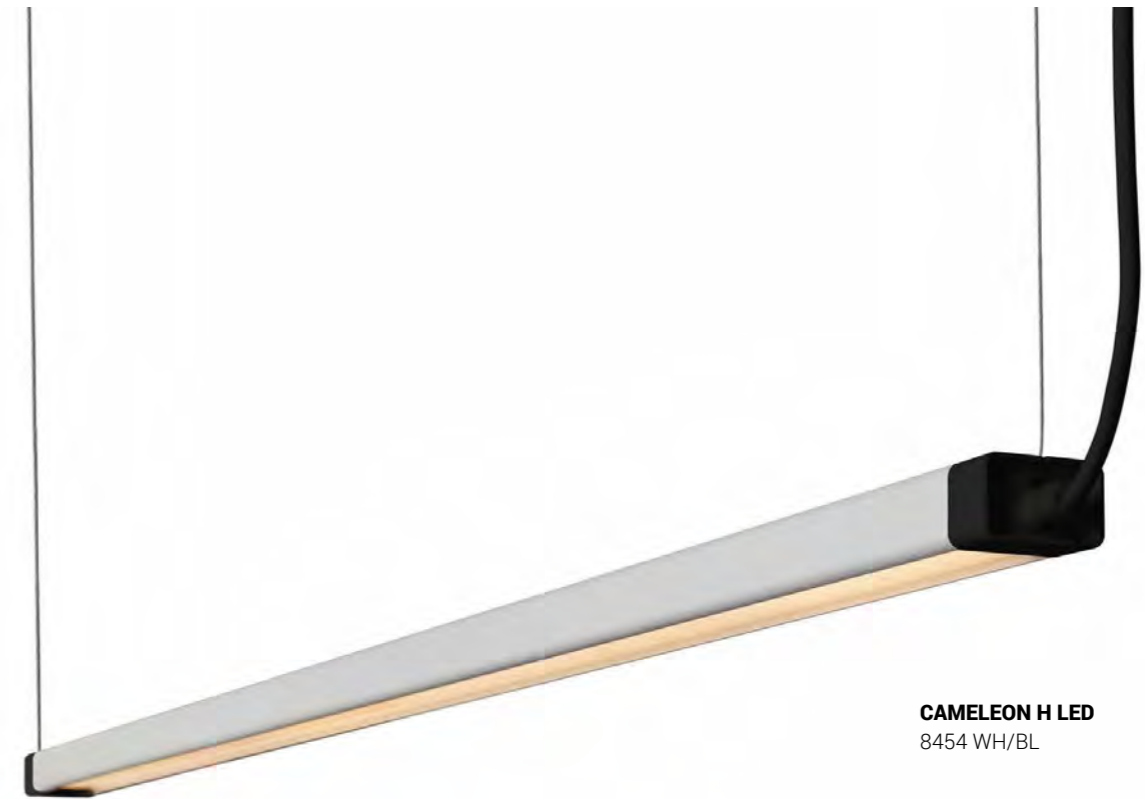

## CAMELEON H LED

painted steel, PC / stal lakierowana, PC / лакированная сталь, PC

8455 ○ WH 8454 ● WH/BL

36W LED

works with / zastosuj z / применять с

A (8566 WH, 8564 BL), B (8610 WH, 8608 BL)  
E (8551 WH, 8550 BL), F (8548 WH, 8547 BL)

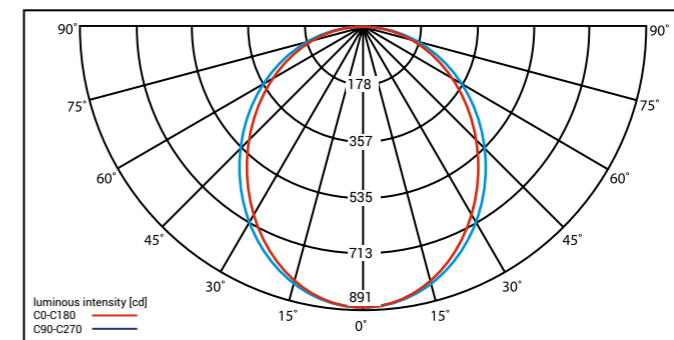

Item No.	INPUT POWER	COLOUR TEMP.	LUMINOUS FLUX	LUMINAIRE EFFICIENCY	COLOUR RENDERING INDEX (CRI ≥)	INPUT	LIFETIME
8455, 8454	36 W LED	3000K	2300 lm	65 lm/W	80	~230V, 50Hz	50 000 h

**CAMELEON  
CANOPY A**  
8566 WH

**CAMELEON Q LED**  
8453 WH





**CAMELEON A LED**  
8451 WH

## CAMELEON A LED

painted steel, PC / stal lakierowana, PC / лакированная сталь, PC

8451 ○ WH 8450 ● BL

36W LED

works with / zastosuj z / применять с

A (8566 WH, 8564 BL), B (8610 WH, 8608 BL)  
E (8551 WH, 8550 BL), F (8548 WH, 8547 BL)

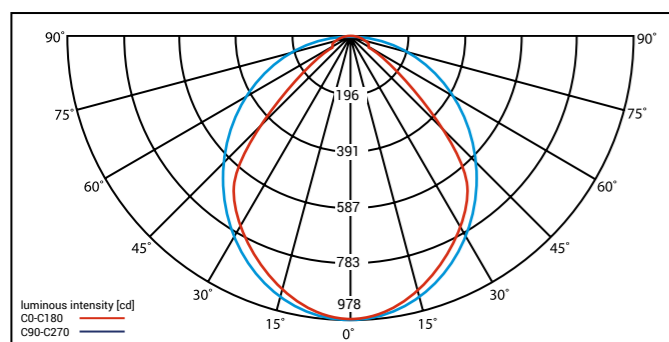
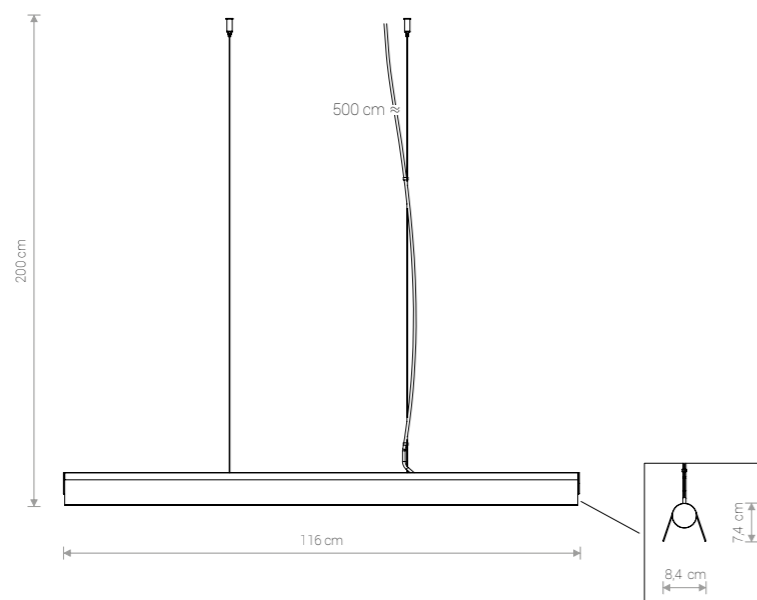

Beam cone diagram - 8451 WH

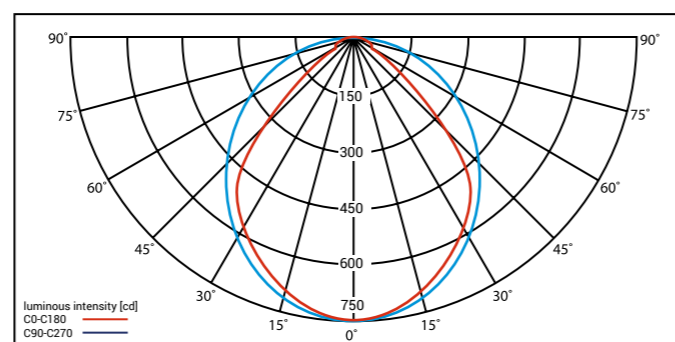

Beam cone diagram - 8450 BL

Item No.	INPUT POWER	COLOUR TEMP.	LUMINOUS FLUX	LUMINAIRE EFFICIENCY	COLOUR RENDERING INDEX (CRI ≥)	INPUT	LIFETIME
8451	36 W LED	3000K	2200 lm	60 lm/W	80	~230V, 50Hz	50 000 h
8450	36 W LED	3000K	1500 lm	40 lm/W	80	~230V, 50Hz	50 000 h



**CAMELEON Q LED**  
8452 BL

## CAMELEON Q LED

painted steel, PC / stal lakierowana, PC / лакированная сталь, PC

8453 ○ WH 8452 ● BL

36W LED

works with / zastosuj z / применять с

A (8566 WH, 8564 BL), B (8610 WH, 8608 BL)  
E (8551 WH, 8550 BL), F (8548 WH, 8547 BL)

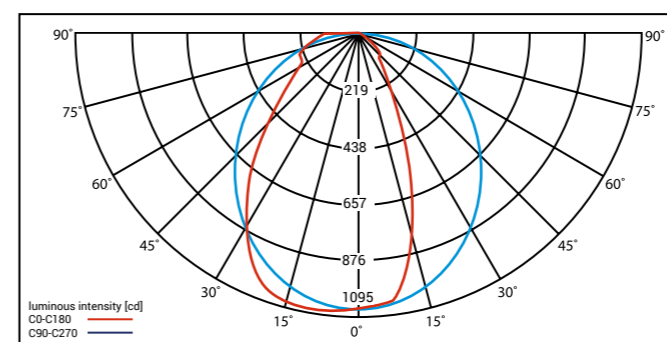
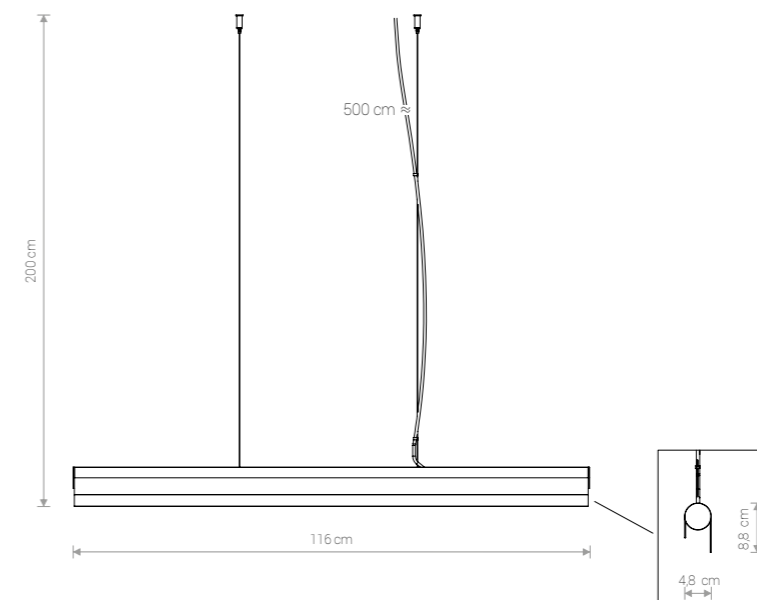

Beam cone diagram - 8453 WH

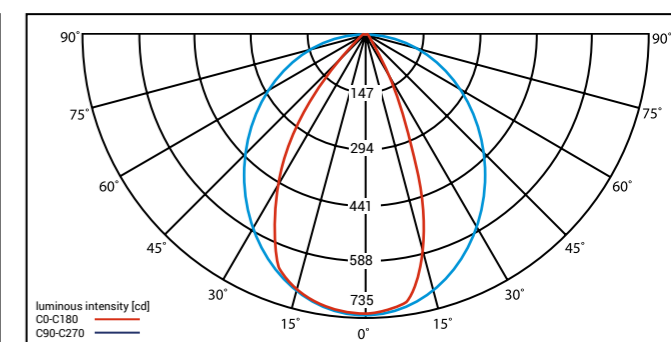

Beam cone diagram - 8452 BL

Item No.	INPUT POWER	COLOUR TEMP.	LUMINOUS FLUX	LUMINAIRE EFFICIENCY	COLOUR RENDERING INDEX (CRI ≥)	INPUT	LIFETIME
8453	36 W LED	3000K	2100 lm	60 lm/W	80	~230V, 50Hz	50 000 h
8452	36 W LED	3000K	1100 lm	30 lm/W	80	~230V, 50Hz	50 000 h

## CAMELEON CABLE E27 | max 40W

silicone, steel / silikon, stal /  
силикон, сталь



● BL

LENGHT	ITEM NO.
1,5 m	8670
2,5 m	8667
3,5 m	8668
5 m	8664
7 m	8663

silicone, steel / silikon, stal /  
силикон, сталь



○ WH

LENGHT	ITEM NO.
1,5 m	8654
2,5 m	8652
3,5 m	8653
5 m	8648
7 m	8647

silicone, steel / silikon, stal /  
силикон, сталь



● BL/BS

LENGHT	ITEM NO.
1,5 m	8666
2,5 m	8665
3,5 m	8662
5 m	8661
7 m	8660

silicone, steel / silikon, stal /  
силикон, сталь



● BL/CH

LENGHT	ITEM NO.
1,5 m	8658
2,5 m	8657
3,5 m	8656
5 m	8655
7 m	8651

silicone, steel / silikon, stal /  
силикон, сталь



○ WH/CH

LENGHT	ITEM NO.
1,5 m	8650
2,5 m	8646
3,5 m	8645
5 m	8644
7 m	8643

## CAMELEON CABLE G9 | max 10W only LED

silicone, steel / silikon, stal /  
силикон, сталь



● BL

LENGHT	ITEM NO.
1,5 m	8632
2,5 m	8631
3,5 m	8627
5 m	8626
7 m	8625

silicone, steel / silikon, stal /  
силикон, сталь



○ WH

LENGHT	ITEM NO.
1,5 m	8640
2,5 m	8638
3,5 m	8637
5 m	8636
7 m	8634

silicone, steel / silikon, stal /  
силикон, сталь



● BL/BS

LENGHT	ITEM NO.
1,5 m	8622
2,5 m	8621
3,5 m	8618
5 m	8616
7 m	8615

silicone, steel / silikon, stal /  
силикон, сталь



● BL/CH

LENGHT	ITEM NO.
1,5 m	8601
2,5 m	8598
3,5 m	8623
5 m	8595
7 m	8594

silicone, steel / silikon, stal /  
силикон, сталь



○ WH/CH

LENGHT	ITEM NO.
1,5 m	8585
2,5 m	8583
3,5 m	8624
5 m	8580
7 m	8578

## CAMELEON CABLE GU10 | max 10W only LED

silicone, steel / silikon, stal /  
силикон, сталь



● BL/CH

LENGHT	ITEM NO.
1,5 m	8635
2,5 m	8633
3,5 m	8641
5 m	8630
7 m	8628

silicone, steel / silikon, stal /  
силикон, сталь



○ WH/CH

LENGHT	ITEM NO.
1,5 m	8620
2,5 m	8617
3,5 m	8642
5 m	8614
7 m	8613

## CAMELEON CABLE WITH SWITCH

silicone, plastic / silikon, plastik /  
силикон, пластики



8611 ● BL 8612 ○ WH

LENGHT	ITEM NO.
1,5 m	8611
1,5 m	8612

works with CANOPY A /  
zastosuj z PUSZKA A /  
применять с ОСНОВАНИЕ A

8565 ● BL □ 8563 ○ WH □

## CAMELEON CANOPY

CAMELEON PUSZKA

CAMELEON ОСНОВАНИЕ

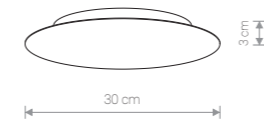

## CANOPY A

painted steel, plastic / stal laskierowana, tworzywo sztuczne /  
лакированная сталь, пластик

works with / zastosuj z / применять с

Ⓧ max 8 lamps × max 40W □

8566 ○ WH 8564 ● BL

works with / zastosuj z / применять с

Ⓧ max 12 lamps × max 40W □

8565 ○ WH 8563 ● BL

application: wall / ceiling  
zastosowanie: ściana / sufit  
применение: стена / потолок



## CANOPY D 780

painted steel / stal laskierowana /  
лакированная сталь

works with / zastosuj z / применять с

Ⓧ max 12 lamps × max 40W □

8552 ● BL 8553 ○ WH

application: wall / ceiling  
zastosowanie: ściana / sufit  
применение: стена / потолок

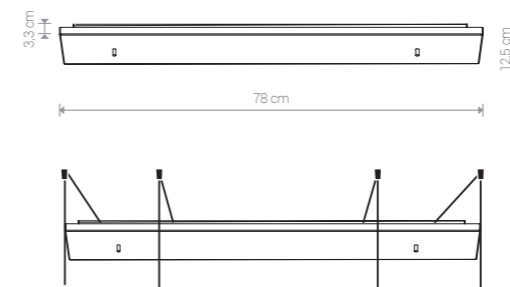

# CAMELEON CANOPY

CAMELEON PUSZKA  
CAMELEON OCHOVANIE

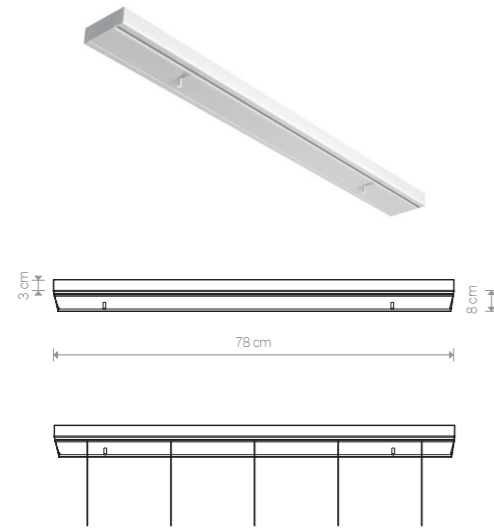

## CANOPY B 780

painted steel / stal laskierowana / лакированная сталь

works with / zastosuj z / применять с

Ⓛ max 12 lamps × max 40W □  
8562 ○ WH 8561 ● BL

application: wall / ceiling  
zastosowanie: ściana / sufit  
применение: стена / потолок

# CAMELEON CANOPY

CAMELEON PUSZKA  
CAMELEON OCHOVANIE

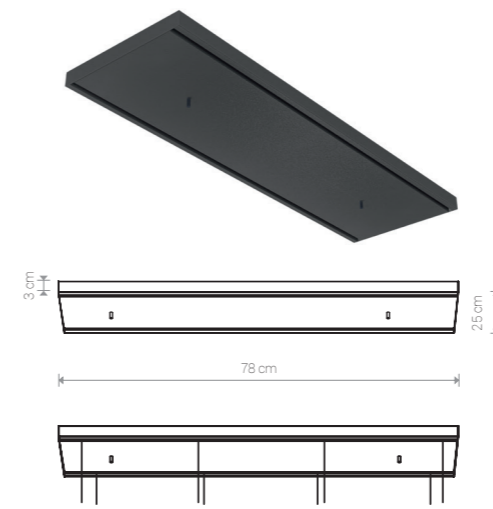

## CANOPY C 780

painted steel / stal laskierowana / лакированная сталь

works with / zastosuj z / применять с

Ⓛ max 12 lamps × max 40W □  
8556 ● BL 8557 ○ WH

application: wall / ceiling  
zastosowanie: ściana / sufit  
применение: стена / потолок



## CANOPY B 1500

painted steel / stal laskierowana / лакированная сталь

works with / zastosuj z / применять с

Ⓛ max 8 lamps × max 40W ⊕ □  
8610 ○ WH 8608 ● BL

works with / zastosuj z / применять с

Ⓛ max 12 lamps × max 40W □  
8560 ○ WH 8558 ● BL

application: wall / ceiling  
zastosowanie: ściana / sufit  
применение: стена / потолок



## CANOPY C 1200

painted steel / stal laskierowana / лакированная сталь

works with / zastosuj z / применять с

Ⓛ max 12 lamps × max 40W □  
8554 ● BL 8555 ○ WH

application: wall / ceiling  
zastosowanie: ściana / sufit  
применение: стена / потолок

## CAMELEON CANOPY

CAMELEON PUSZKA  
CAMELEON OSNOVANIE

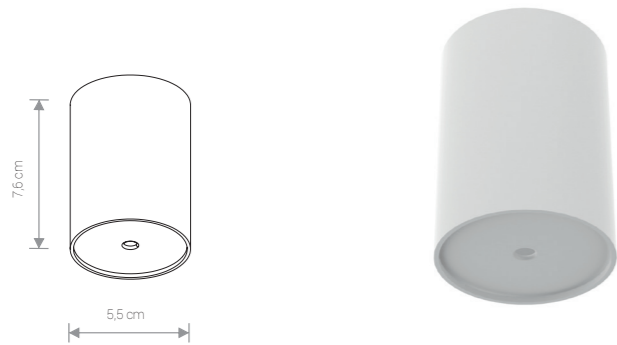

### CANOPY E

painted steel / stal laskierowana /  
лакированная сталь

works with / zastosuj z / применять с

max 1 lamp × max 40W  
8551 ○ WH 8550 ● BL

application: ceiling  
zastosowanie: sufit  
применение: потолок

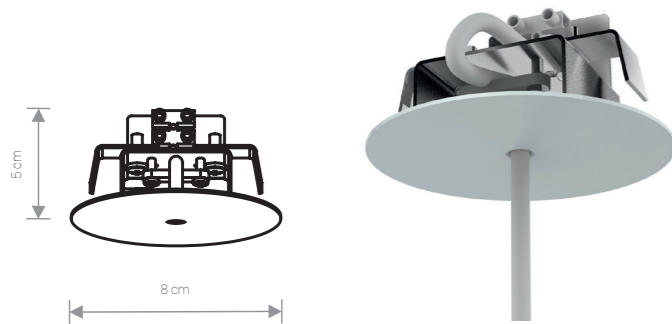

### CANOPY F

painted steel / stal laskierowana /  
лакированная сталь

works with / zastosuj z / применять с

max 1 lamp × max 40W  
8548 ○ WH 8547 ● BL

application: ceiling  
zastosowanie: sufit  
приложение: потолок

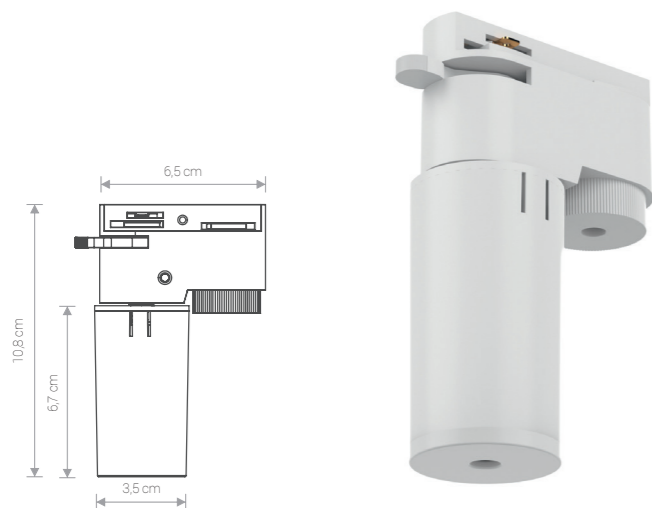

### CANOPY G

plastic / plastik / пластики

works with / zastosuj z / применять с

max 1 lamp × max 40W  
8361 ○ WH 8360 ● BL

application: ceiling  
zastosowanie: sufit  
приложение: потолок

works with / zastosuj z / применять с

PROFILE TRACK system (Catalogue 2019/2020) /  
PROFILE TRACK system (Katalog 2019/2020) /  
система PROFILE TRACK (Catalogue 2019/2020)

## CAMELEON FIXING

CAMELEON AKCESORIA MONTAŻOWE  
CAMELEON АКССУАРЫ ДЛЯ КРЕПЛЕНИЯ

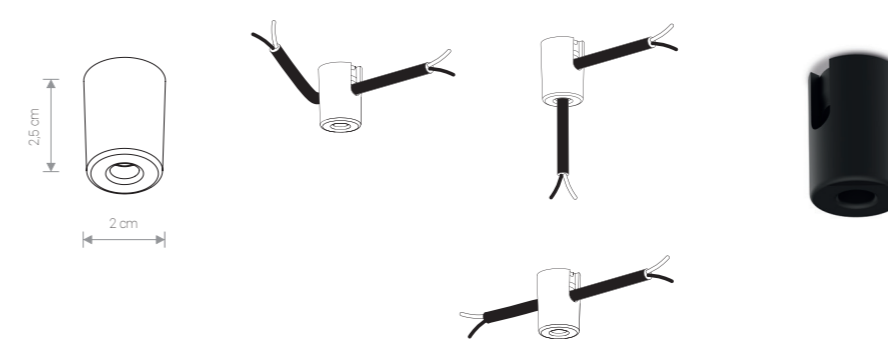

### CAMELEON MOUNTING A

CAMELEON MOUNTING A - included (3pcs). Mounting screws are not included /  
Zestaw zawiera 3 sztuki elementu CAMELEON MOUNTING A. Zestaw nie zawiera wkrętów montażowych /  
CAMELEON MOUNTING A - включено (3 шт.). Монтажные винты не включены

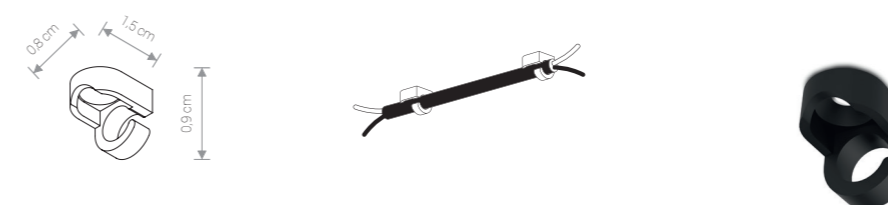

### CAMELEON MOUNTING B

CAMELEON MOUNTING B included (5pcs). Mounting screws are included (5pcs) /  
Zestaw zawiera 5 sztuk elementu CAMELEON MOUNTING B. Zestaw zawiera 5 sztuk wkrętów montażowych /  
CAMELEON MOUNTING B - включено (5 шт.). Монтажные винты включены (5 шт.)

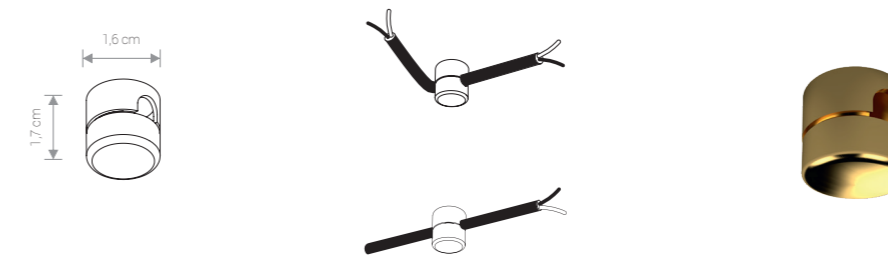

### CAMELEON MOUNTING C

CAMELEON MOUNTING C - included (5pcs). Mounting screws - not included /  
Zestaw zawiera 5 sztuk elementu CAMELEON MOUNTING C. Zestaw nie zawiera wkrętów montażowych /  
CAMELEON MOUNTING C - включено (5 шт.). Монтажные винты не включены

## CAMELEON MOUNTING A

plastic / tworzywo sztuczne / пластик  
8395 ● BL 8396 ○ WH

application: wall / ceiling  
zastosowanie: ściana / sufit  
применение: стена / потолок

allows the change of wire direction  
umożliwia zmianę kierunku przebiegu przewodu

## CAMELEON MOUNTING B

plastic / tworzywo sztuczne / пластик  
8393 ● BL 8394 ○ WH

application: wall / ceiling  
zastosowanie: ściana / sufit  
применение: стена / потолок

prevents wire from sagging  
zapobiega obwisaniu przewodu







## CAMELEON MOUNTING C

brass / miedź / латунь  
8405 ● BS

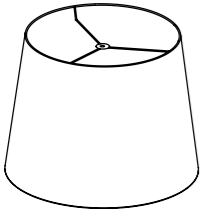
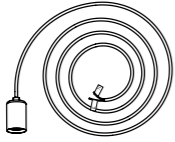
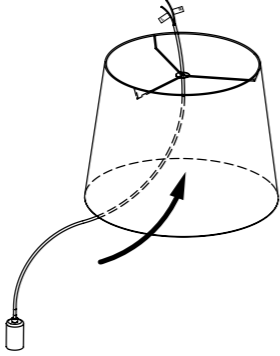
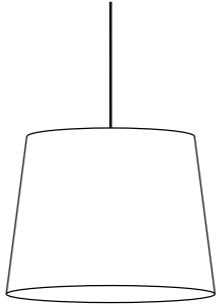
application: wall / ceiling  
zastosowanie: ściana / sufit  
применение: стена / потолок

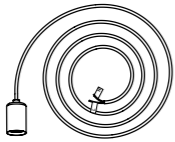
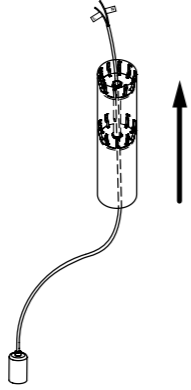
prevents wire from sagging  
zapobiega obwisaniu przewodu

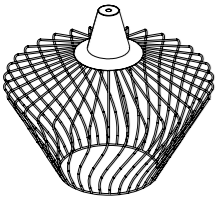
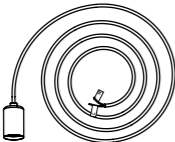
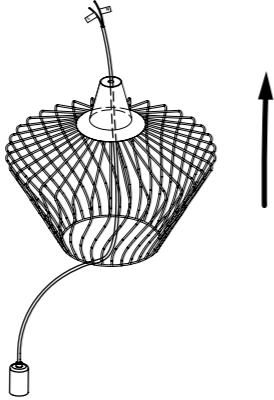
# CAMELEON MANUALS

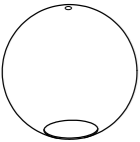
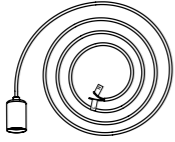
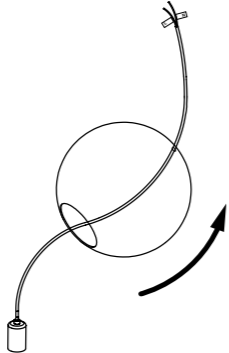
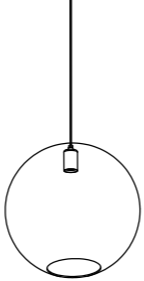
LAMP SHADE	SUSPENSION	SUSPENSION + LAMP SHADE	READY FOR INSTALLATION
KLOSZ АБАЖУРЫ	ZAWIESZENIE ПОДВЕС	ZAWIESZENIE + KLOSZ ПОДВЕС + АБАЖУРЫ	GOTOWE DO ZAMONTOWANIA ГОТОВ К МОНТАЖУ
			
			
			
			

# CAMELEON POSSIBILITIES

CANOPY A

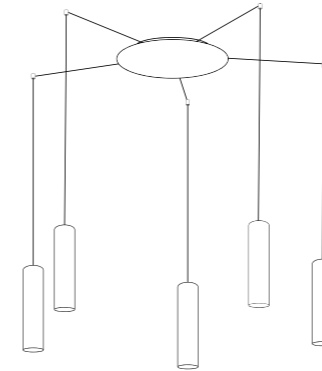

CANOPY B

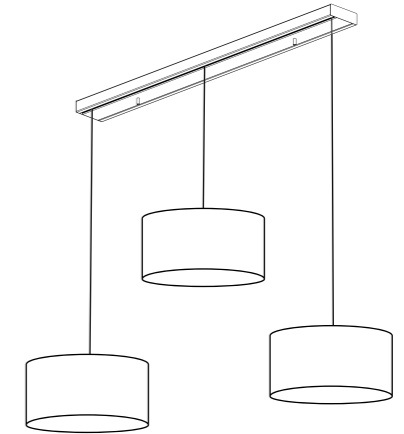

CANOPY C

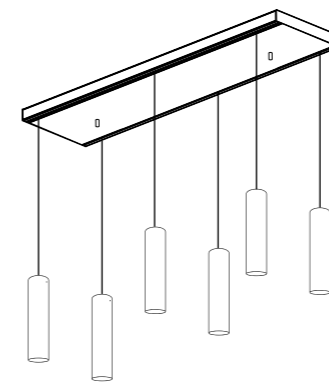

CANOPY D

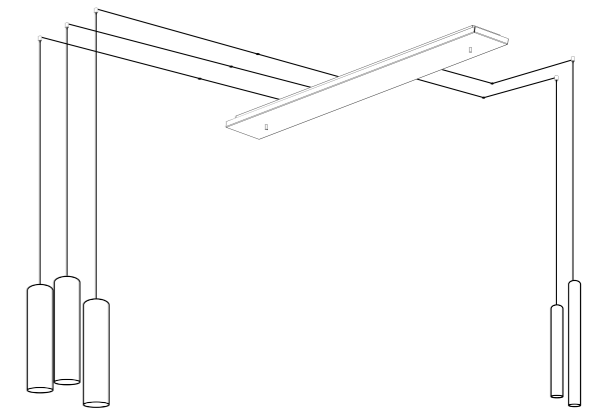

CANOPY E

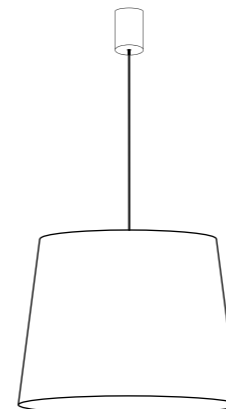

CANOPY F

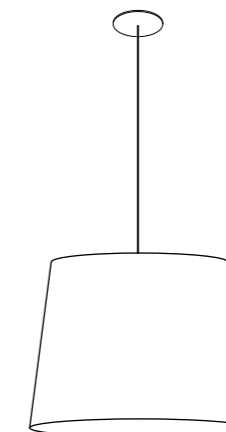

CANOPY G

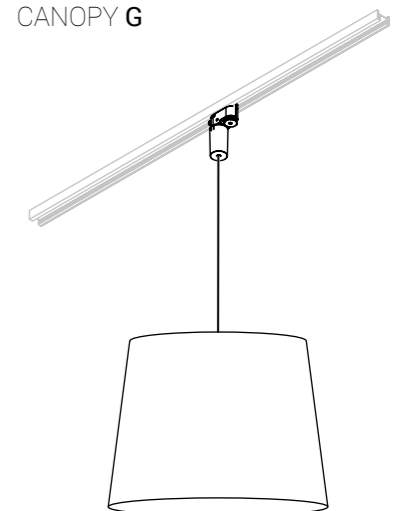

# CANOPY A

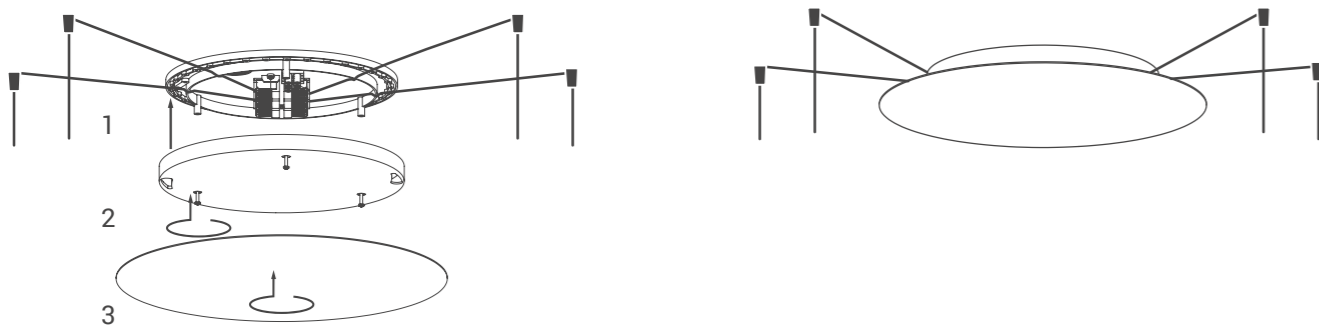
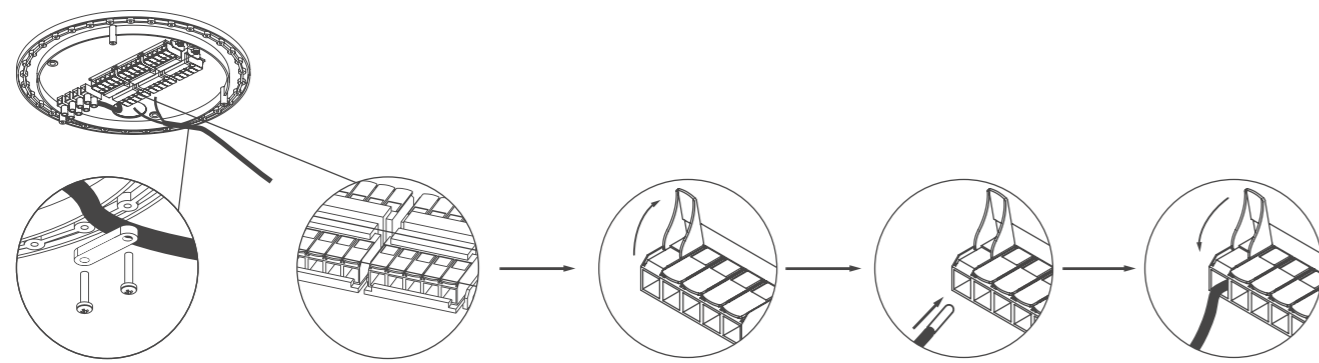
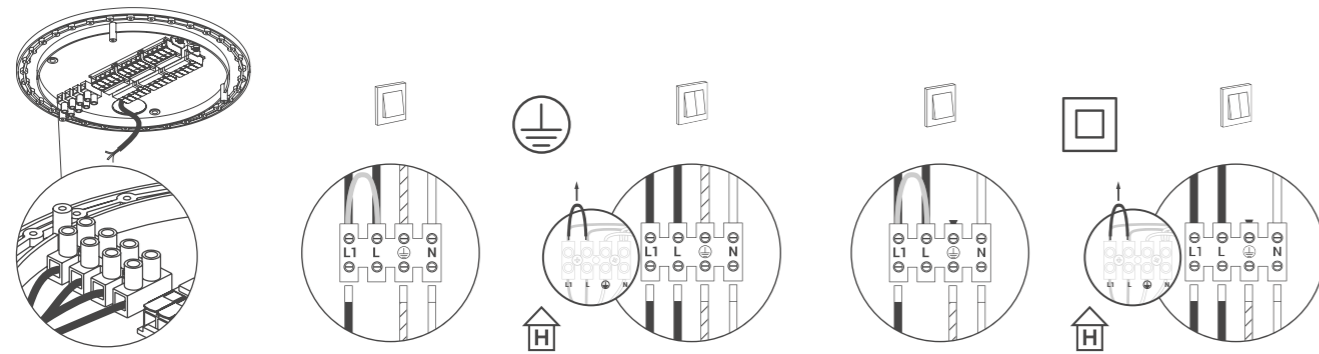
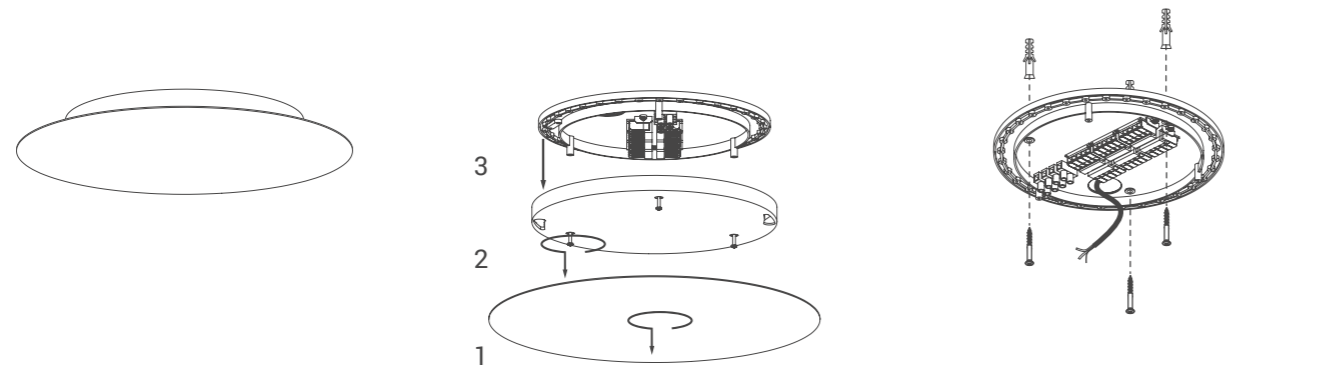

# ZONES CANOPY A

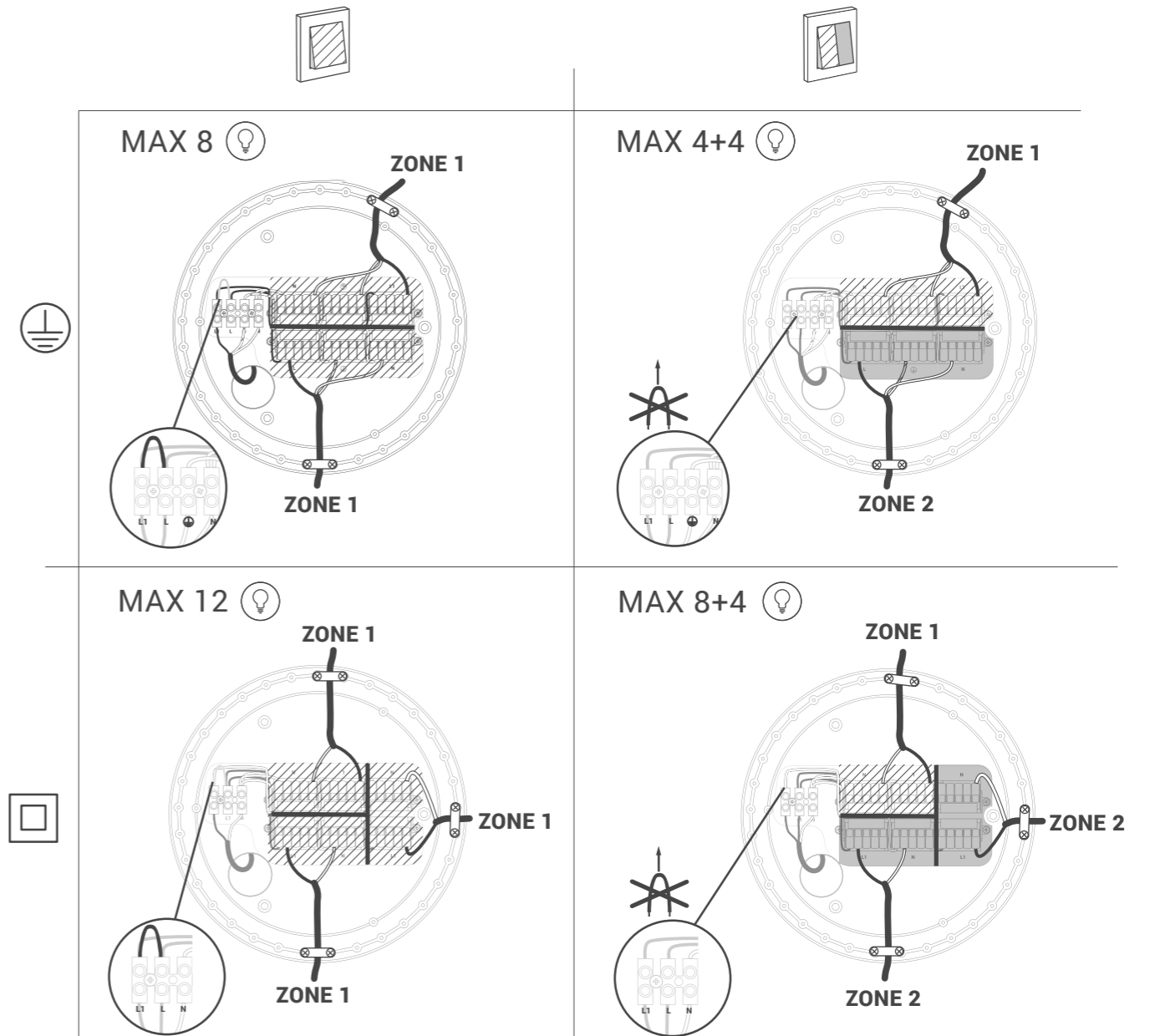
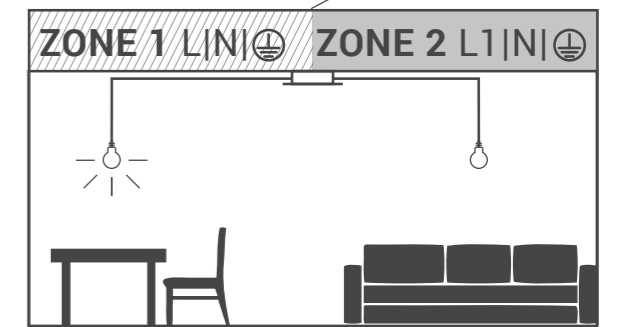
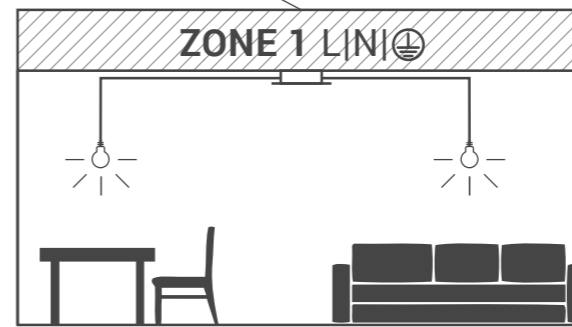



# CANOPY B, C, D

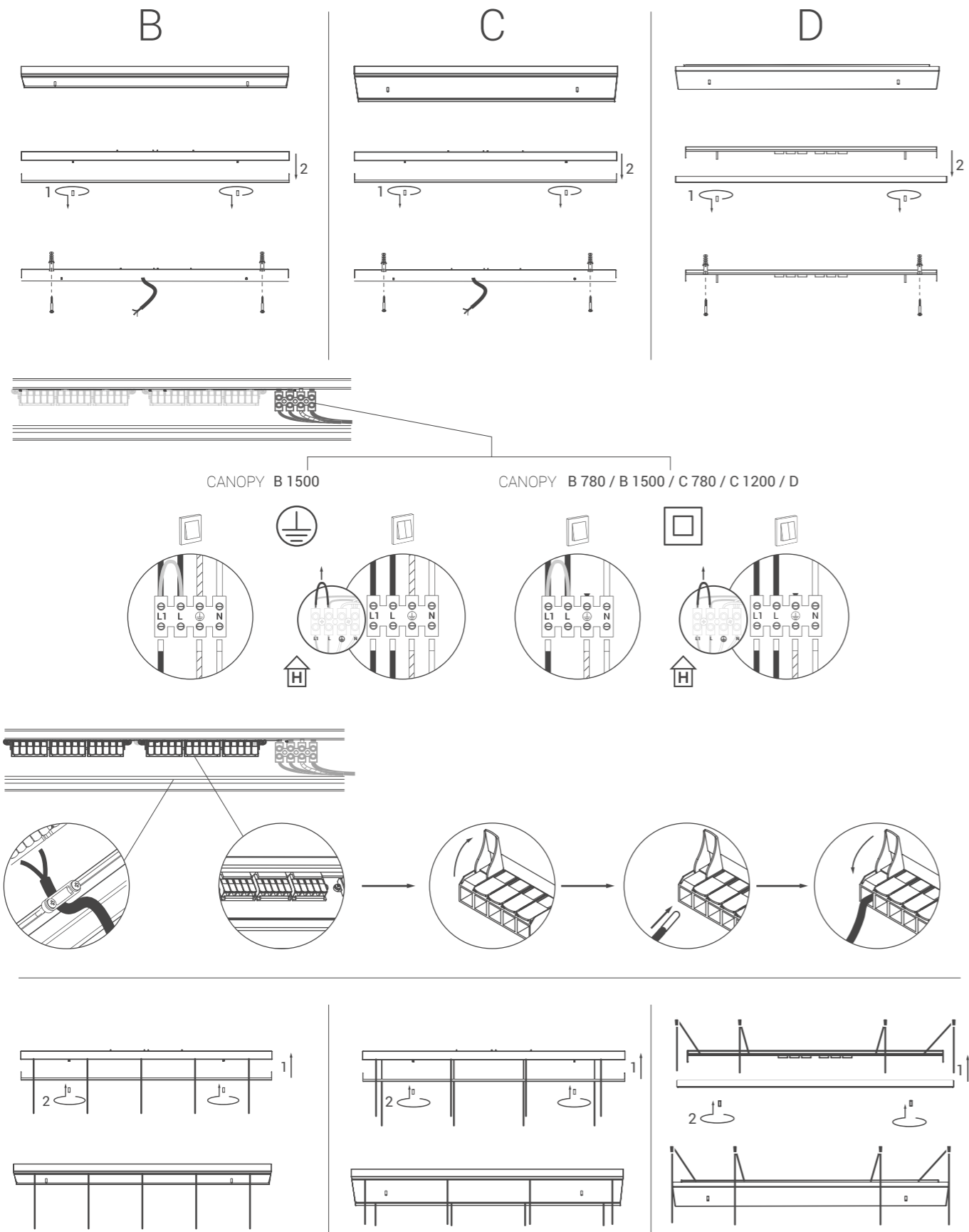

# ZONES CANOPY B, C, D

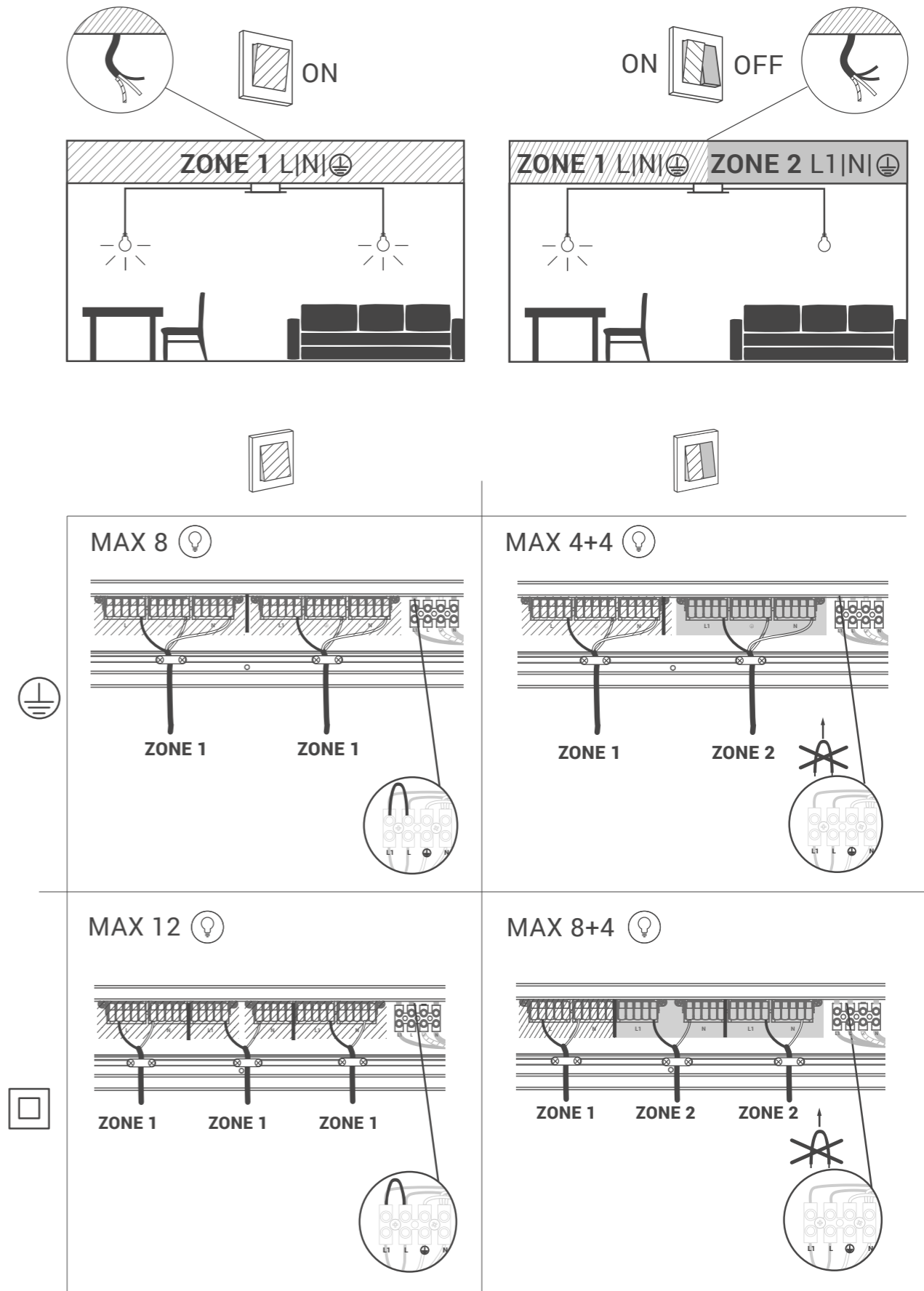

# CANOPY E

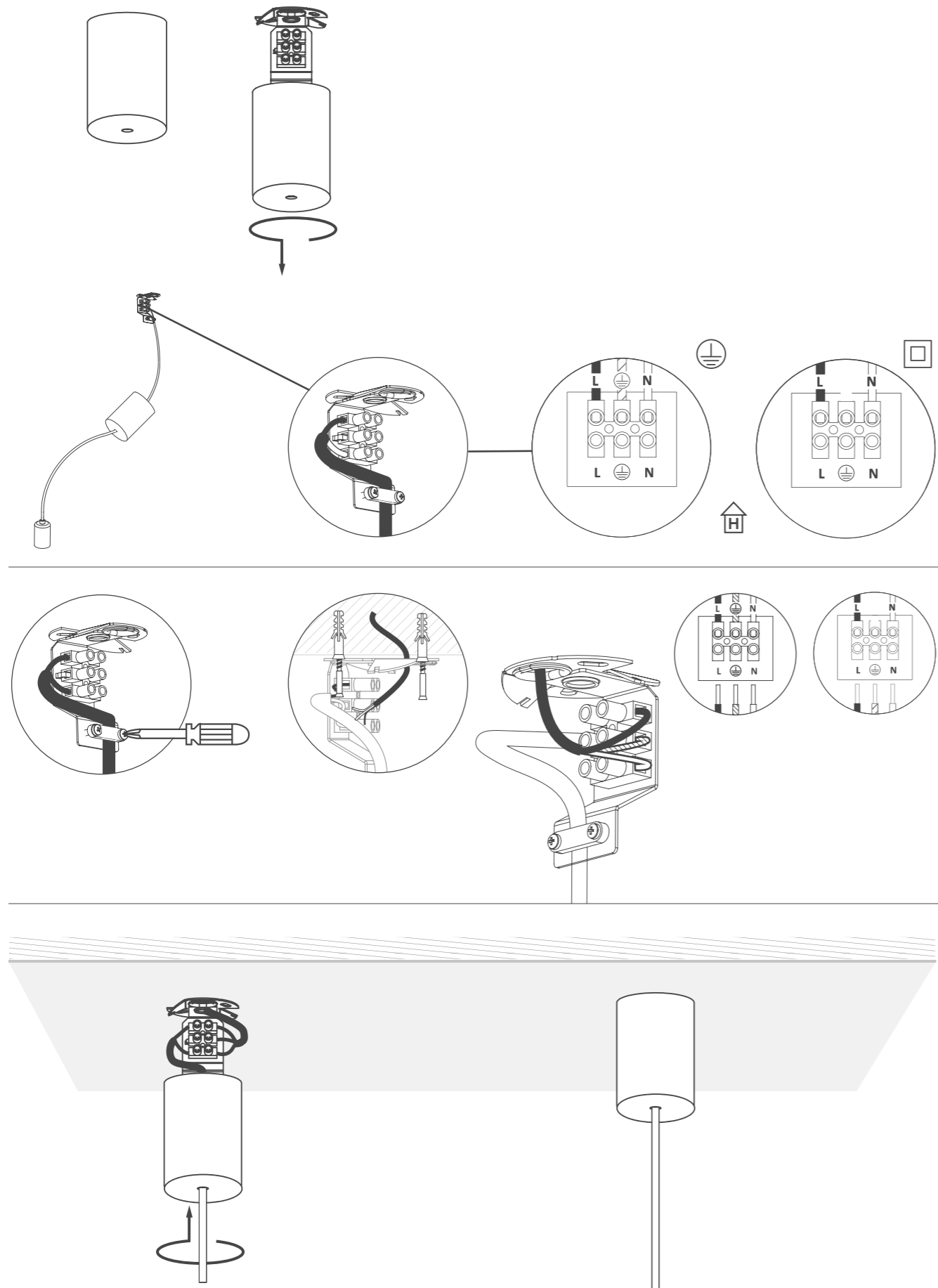

# CANOPY F

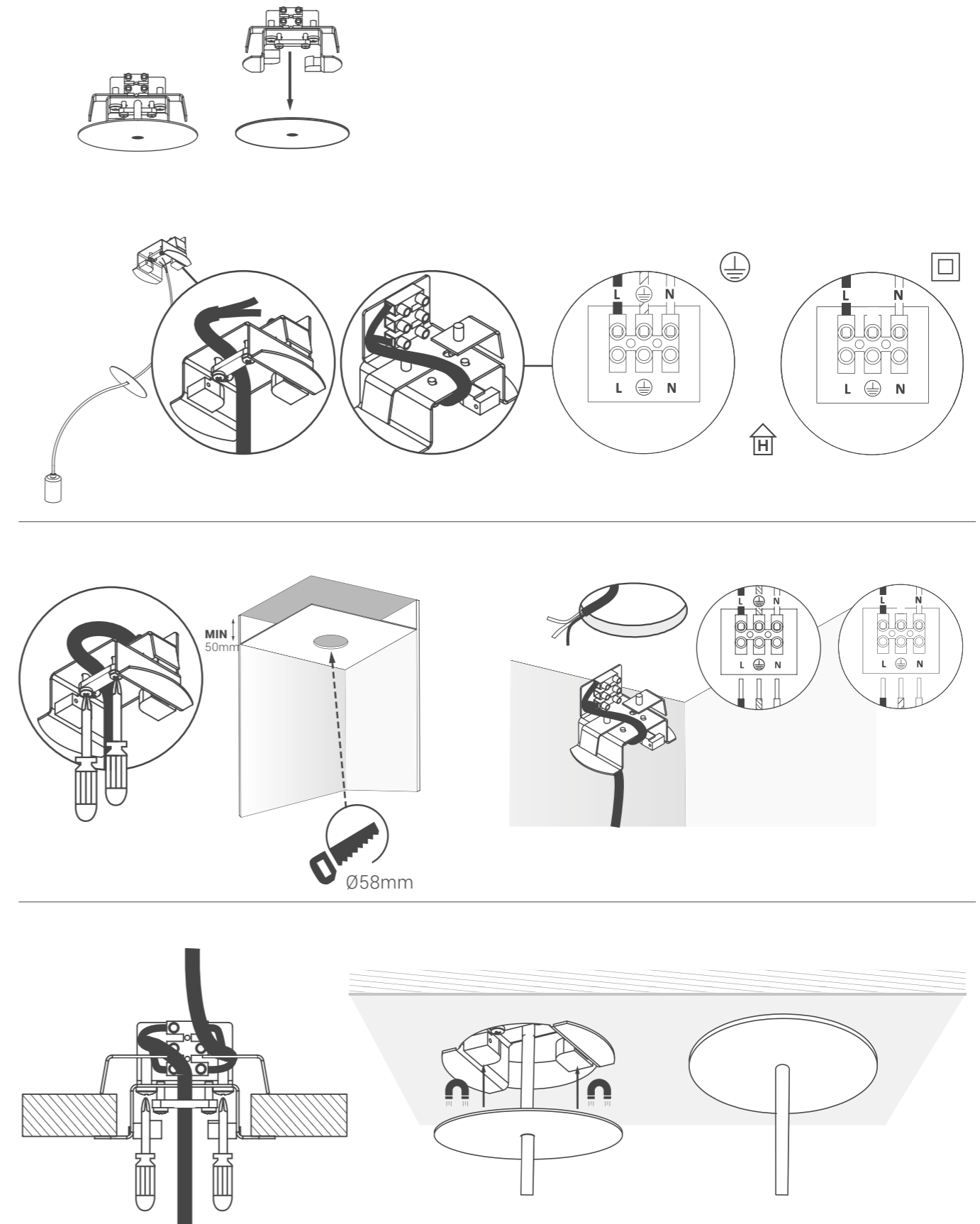

CANOPY G

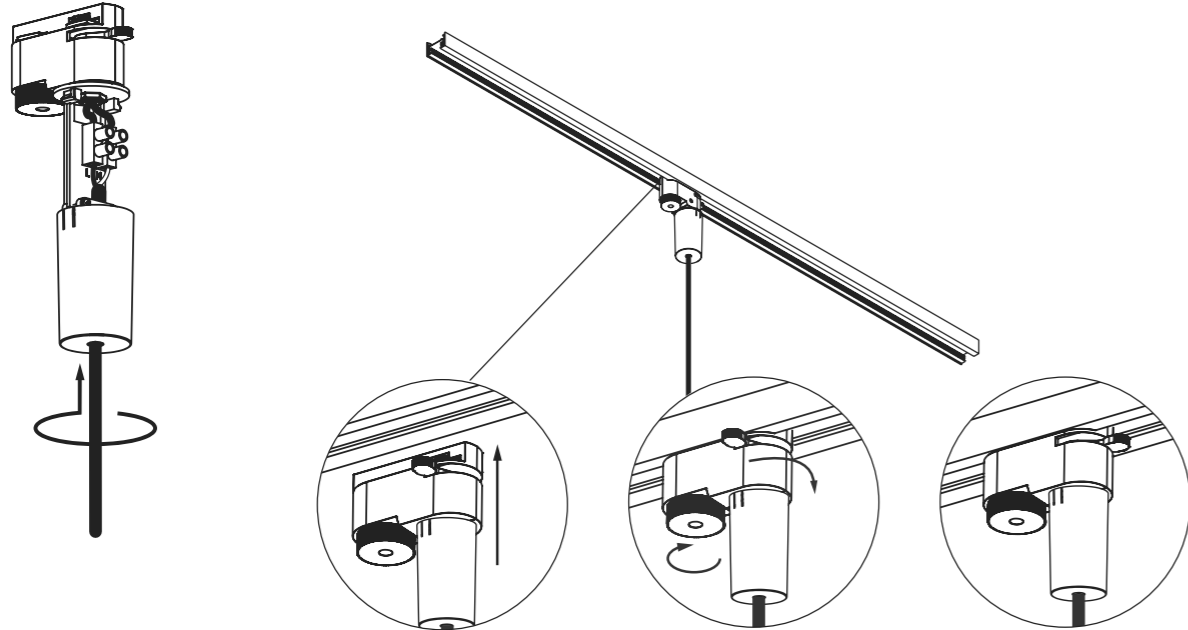
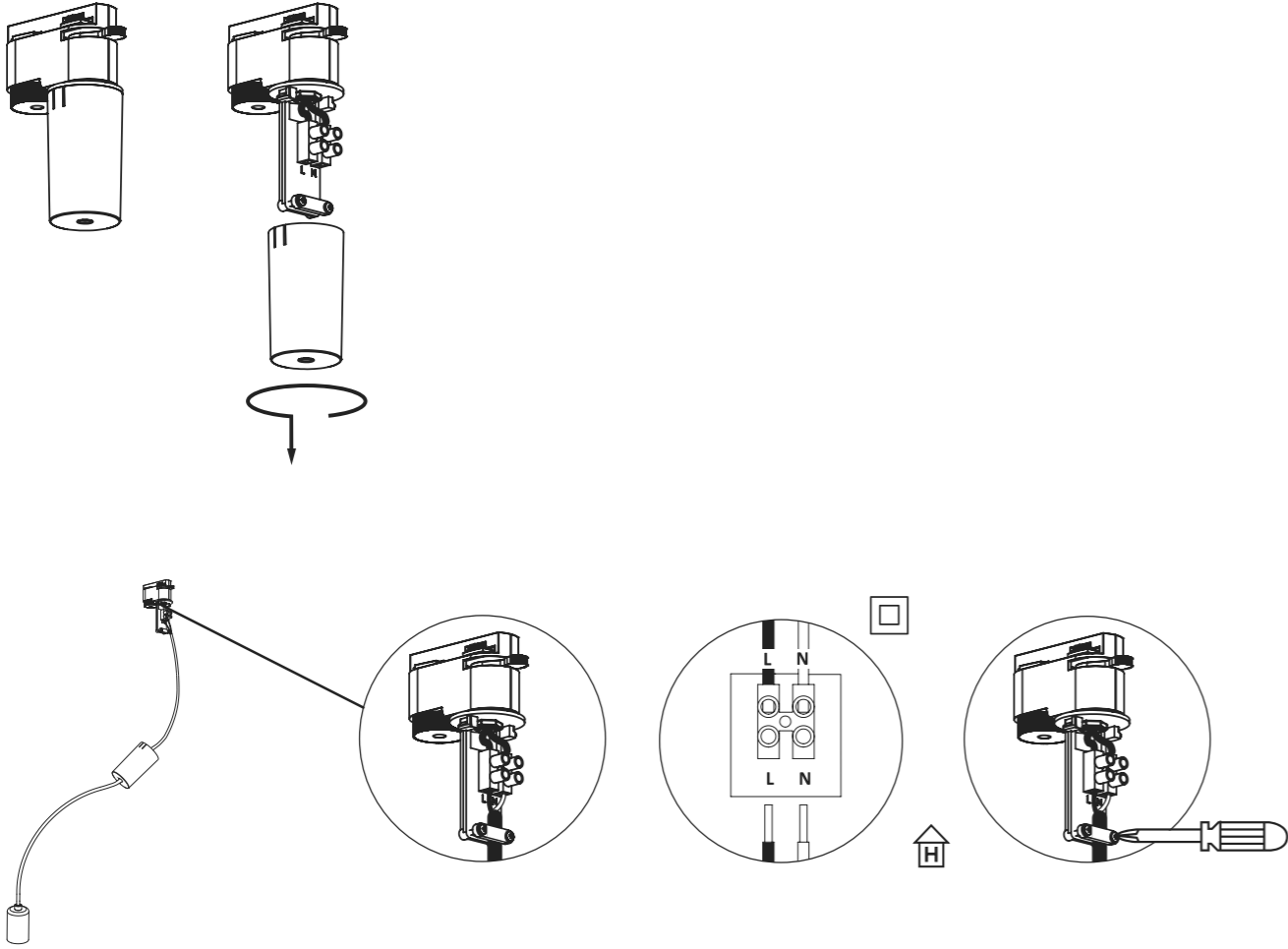

MOUNTING A, B, C

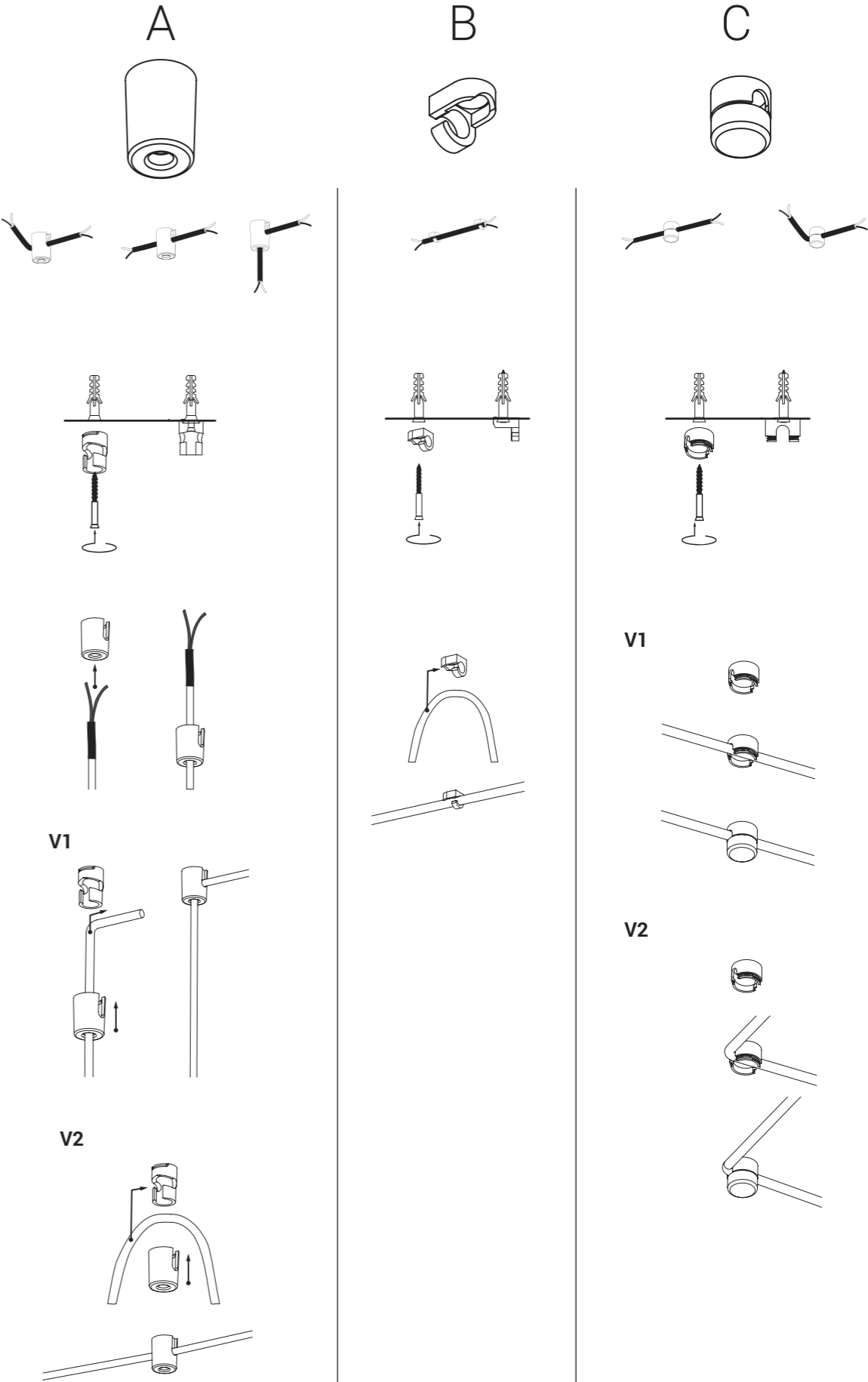

# ALPHABETICAL INDEX / ALFABETYCZNY SPIS TREŚCI

<b>A</b>	<b>G</b>
ABI L .....23	GEOMETRIC A .....35
ABI M .....23	GEOMETRIC B .....35
ABI S .....23	GEOMETRIC C .....35
A LED .....66	GSTAR .....25
<b>B</b>	<b>H</b>
BARREL L .....60	H LED .....63
BARREL THIN S .....59	
BARREL WIDE S .....58	<b>L</b>
BIO M .....46	LASER 490 .....28
BIO S .....46	LASER 750 .....28
<b>C</b>	LASER 1000 .....28
CABLE E27 .....68	LUKSOR L .....21
CABLE G9 .....68	LUKSOR S .....21
CABLE GU10 .....68	<b>M</b>
CANOPY A .....69	MOUNTING A .....73
CANOPY B 780 .....70	MOUNTING B .....73
CANOPY B 1500 .....70	MOUNTING C .....73
CANOPY C 780 .....71	<b>P</b>
CANOPY C 1200 .....71	PEAR L .....43
CANOPY D 780 .....69	PEAR M .....43
CANOPY E .....72	PEAR S .....43
CANOPY F .....72	PICO A .....22
CANOPY G .....72	PICO B .....22
CONE L .....53	PICO C .....22
CONE M .....52	POLY L .....32
CONE S .....54	POLY M .....32
CYLINDER L .....38	<b>Q</b>
CYLINDER M .....38	Q LED .....67
CYLINDER S .....38	<b>S</b>
<b>D</b>	SPHERE L .....44
DOVER .....47	SPHERE M .....44
<b>E</b>	SPHERE S .....44
EGG M .....26	
EYE L .....30-31	
EYE M .....30-31	

SPHERE XL .....44	<b>U</b>
STRAW M .....39	UMBRELLA .....25
STRAW S .....39	<b>W</b>
<b>T</b>	WAVE L .....19
TULUM .....33	WAVE S .....19
	WHEEL .....48

# PROGRESSIVE CODE INDEX / INDEKS LAMP





INDEX	PAGE/STRONA	INDEX	PAGE/STRONA	INDEX	PAGE/STRONA	INDEX	PAGE/STRONA
8360	72	8451	66	8491	53	8525	59
8361	72	8452	67	8492	53	8526	59
8393	73	8453	67	8493	53	8527	44
8394	73	8454	63	8494	53	8528	44
8395	73	8455	63	8495	52	8530	44
8396	73	8457	46	8496	52	8531	44
8400	39	8458	46	8497	52	8532	43
8401	39	8461	46	8498	52	8533	43
8402	39	8462	46	8500	54	8534	43
8403	39	8463	47	8501	54	8535	39
8405	73	8464	47	8502	54	8536	39
8406	53	8465	35	8503	54	8537	38
8407	53	8466	35	8504	54	8538	38
8408	53	8467	33	8505	54	8540	38
8410	53	8471	32	8506	60	8541	38
8411	52	8472	32	8507	60	8542	38
8412	52	8473	32	8508	60	8543	38
8413	52	8474	32	8510	60	8544	38
8414	52	8475	31	8511	60	8545	38
8415	54	8476	31	8512	58	8546	38
8416	54	8477	31	8513	58	8547	72
8417	60	8478	31	8514	58	8548	72
8418	60	8480	31	8515	58	8550	72
8420	60	8481	31	8516	58	8551	72
8421	58	8482	31	8517	58	8552	69
8422	59	8483	31	8518	58	8553	69
8423	48	8484	30	8520	59	8554	71
8424	48	8485	30	8521	59	8555	71
8425	35	8486	28	8522	59	8556	71
8426	33	8487	28	8523	59	8557	71
8450	66	8488	28	8524	59	8558	70



# Nowodvorski

L I G H T I N G

Nowodvorski sp.j.  
 ul. Bojemskiego 11  
42-202 Częstochowa  
POLAND

 +48 34 344 91 10 / 11  
 +48 34 344 91 12  
 nowodvorski@nowodvorski.com  
 www.nowodvorski.com



Design & production

**GRAFFITI**  
CREATIVE PEOPLE

[www.graffiti.com.pl](http://www.graffiti.com.pl)

# Nowodvorski

L I G H T I N G

Nowodvorski sp.j.  
ul. Bojemskiego 11  
42-202 Częstochowa  
POLAND

 +48 34 344 91 10/11

 [nowodvorski@nowodvorski.com](mailto:nowodvorski@nowodvorski.com)



[www.nowodvorski.com](http://www.nowodvorski.com)